

EARLY RISER[®]

1200 SERIES PLANTER



CASE IH PLANTER PRODUCTIVITY GUIDE

www.caseih.com

CASE IH
AGRICULTURE

1200 SERIES EARLY RISER® PLANTER



CONTENTS

General Information	3-4
Planter Configurations	5
Product Support Kits	6-7
Safety	8
Service Inspection	9-11
Operation	12-13
Maintenance	14-24
Adjustments	25-32
Planter Options	33-35
Displays	36-56
Storage	57



GENERAL INFORMATION

For years, successful farmers have relied on Case IH to lead the way with the ultimate planters for their cropping operations. They trust their crop to the combination of the Early Riser Row Unit and the Advanced Seed Meter, knowing that seed placement and metering are *THE* key elements in achieving consistent stands, with the high yields necessary to remain competitive in today's agricultural environment.

The planter row unit must consistently place the seed into direct contact with moist soil, at a uniform depth, with even in-row seed spacing. The Case IH Early Riser row unit delivers the control over these critical factors that is necessary for faster germination for earlier, more even emergence. Zero-indexed depth control assures consistent settings from row-to-row, with quick adjustments to optimize seed placement to moisture conditions.

Equalizing gauge wheels are pulled, not pushed, by the row unit. Gauge wheels easily "walk" over residue and clods to minimize depth variation, and are more stable at faster ground speeds and adverse field conditions. Then, the Early Riser row unit uses offset double disk openers to slice a trench through heavy residue and hard soil. The low angle opener and specially-contoured gauge wheels produce a uniform trench, and retain moist soil next to the trench. A furrow firming point defines the seed trench and firms loose soil, creating the perfect environment for seed entering from the seed tube. Patented covering disks gently squeeze the trench closed, returning moist soil over the seed. Finally, a wide press wheel lightly firms soil on top of the furrow to eliminate air pockets, ensuring optimal seed-to-soil contact for quick germination. The unique chevron tread pattern scores the soil to encourage surface cracking for easier emergence in crust-prone soils. **The attention to seed placement accuracy delivered by the Early Riser is evidenced by proven emergence on average from one to three days faster than with other planter row units.**

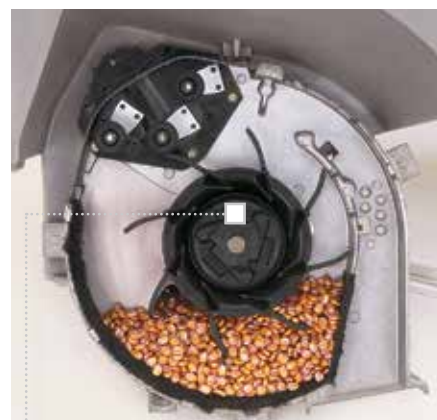

The Advanced Seed Meter uses vacuum technology to precisely control seed metering. The larger seed disk rotates more slowly than other vacuum meters, improving spacing precision, especially at higher speeds. The ASM seed disk has no pockets, instead using the power of vacuum to hold seeds to the flat side of the disk. Seed does not tumble out of the disk, but simply drops from the disk and into the seed tube. Without pockets, disks can plant a wider range of seed sizes with less need to switch disks when changing varieties during busy planting seasons. In fact, the ASM will accurately meter all normal seed corn sizes and grades, with just one vacuum and meter setting.



A special three-spool singulator design consistently delivers one seed, and one seed only, from each meter disk hole. The Advanced Seed Meter singulator is not as sensitive to variations in seed size and shape or vacuum levels, meaning you spend your time planting, not tweaking seed meters to achieve desired seed population.



1200 SERIES EARLY RISER® PLANTER

GENERAL INFORMATION

Combining the Case IH Early Riser row unit and Advanced Seed Meter allows you to confidently achieve accurate planting at faster field speeds. You will cover more acres, more quickly, to again contribute to faster and more consistent emergence. The ASM is simple, **requiring no seasonal calibration or maintenance** to assure you plant the rate you select, year after year. **And unlike other planters, daily and seasonal maintenance requirements are almost non-existent, reducing maintenance cost and time commitments.**

Finally, one of the most important features of your Case IH planter, is your Case IH Dealer. Service after the sale has long been the reason customers keep coming back to Case IH, and we know the importance of on-time planting. That's why our dealers are required to complete comprehensive product training every two years; and carry minimum parts inventory, to assure your crops are in the ground on time, using Case IH planters.



Case IH offers a selection of planter designs couple Early Riser and ASM advantages with innovative ways of quickly transforming between field and transport configurations as narrow as 11 ft. 11 in. for front-fold Model 1250/1255, or 12 ft. 3 in. Pivot Transport Model 1240/1245. Quick moves from field to field to help you spend more time planting and less time moving between fields when conditions are right. Once again, Case IH planter advantages get your crop in the ground and growing faster than other planters. Add Case IH Advanced Farming Systems, such as AFS AccuRow Overlap control, AFS AccuStat Advanced Seed Sensing or Prescription Application, and you have the ultimate in modern planting accuracy and efficiency.



The Bulk Fill option on Pivot-Transport and Front-Fold planters cuts seed fill time to a minimum with twin, easy-to-reach hoppers that cover more acres between fills. A simple high volume fan system efficiently move seed from the bulk fill hoppers to row unit mini-hoppers to keep planting up to speed, and row unit weight consistent.

PLANTER CONFIGURATIONS

CASE IH EARLY RISER® SERIES PLANTERS ARE AVAILABLE IN MULTIPLE CONFIGURATIONS TO MATCH ANY FARMING OPERATION:

- 1215 Rigid-Mounted:
6 and 8 row; wide or narrow
- 1225 Rigid-Trailing:
6- or 8-row 30 in.
- 1235 Mounted Stackerbar:
8- and 12-row wide; 12-row narrow,
16-row narrow
- 1245 Pivot-Transport:
12- and 16-row 30 in.; 24-row 20 in.
- 1245 Pivot-Transport Split-Row:
12/23 and 16/31 15/30 in. Split-Row
- 1255 Front-Fold:
12, 16 & 24-row 30 in.
- 1265 Front-Fold:
32-row 30 in.; 36-row 20, 22 and 30 in.



1200 SERIES EARLY RISER® PLANTER

PRODUCT SUPPORT KITS

EARTH METAL OPENER DISK ASSEMBLIES WITH NEW HEAVY DUTY SINGLE ROW LOW PROFILE BEARING



When it comes to the productivity of your Case IH planter, only trust the best. Many product support kits are available to help you repair or replace worn parts. Talk to your Case IH dealer about getting the most out of this season.

PART NUMBER 3.5 MM DISK	PART NUMBER 4.5 MM DISK	PART NUMBER 5 MM DISK	DESCRIPTION
84398745	84416318	73341803	Leading Disk, 14 in. Diameter
84398746	84416319	73341804	Trailing Disk, 14 in. Diameter

- 3.5 mm standard equipment on new MY2013 Case IH planters
- Choose from durable 3.5 mm, 4.5 mm or 5 mm thick Earth Metal® blades
- Includes new heavy duty low profile bearings, bearing flange and 5/16 in. rivets
- Higher bearing load ratings mean reliable performance in the toughest, most demanding conditions
- Heavy-duty seals protect bearings from contamination and assure bearing lubricant retention

Note: If replacing the standard opener or HD double bearing opener with the new HD single row bearing additional parts will be required. Replacing standard opener — LH 2-in. bolt P/N – 86508732, RH 2-in. bolt P/N – 87698796, & protective washer P/N – 84058945 (1 for each opener). Replacing double bearing opener — Reuse 2-in. hardware, install protective washer P/N – 84058945 (1 for each opener), remove/discard bearing cap.

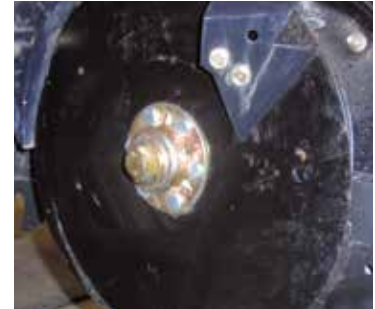

Hydraulic Seed Drive conversion kit for the 1250 & 1255 12 & 16 row planters – Part No. 47691328 (PTO Pump) Part No. 47691329 (Direct Drive)

- Allows for the conversion of mechanical transmission seed drives to hydraulic seed drives.
- Change the population rates/VRT from the display in the cab
- AFS Pro 600 or 700 equipped planters only



Firming Point Kit – Part No. B94735

- Application: 800, 900, 950, 955, 1200 planters
- Handy carded two-pack
- Genuine Case IH component



Firming Point & Seed Shoe Kit – Part No. B96489 - 1200 Series Planters Part No. B94595 - 800, 900, 950, 955 planters

- Handy carded service package
- Kit includes: One (1) firming point, one (1) seed shoe, and mounting hardware



Closing Disk Kit – Part No. B95381

- Application: 800, 900, 950, 955, 1200 Series planters
- Genuine Case IH components
- Kit includes: disk assembly (2), dust caps and hardware
- Handy service package



New! Closing Disk Spring Guide Kit – Part No. 84601418

- Application: 800, 900, 950, 955, 1200 planters
- Added reinforcement bushings to lower holes and new retention clamps and bolts
- Genuine Case IH components
- Kit includes: Spring guide, lower pin w/ cotter pin, retention clamps and hardware



Heavy Duty Press Wheel Casting & Closing Disk Spring – Part No. 84606219



- Application: 800, 900, 950, 955, 1200 Series planters
- Ductile Cast Iron Press Wheel (start production MY2012) with heavy-duty spring
- Genuine Case IH components
- Kit Includes: Press wheel support, HD closing disk spring and mounting hardware

PRODUCT SUPPORT KITS

SEED FLOW LUBRICANT

- 100% Graphite or 50/50 Graphite/Talc mix available
- 50/50 Graphite/Talc blend improves seed flow when planting sticky coated seed
- Refer to Operator's Manual for recommended application rates
- Available in 1- or 8-lb. containers



PART NUMBER	PART DESCRIPTION
407486R1	Graphite Seed Lube, 1 lb. bottle
73340733	Graphite Seed Lube, 8 lb. jug
73340370	50/50 Graphite/Talc Seed Lube, 1 lb. bottle
73340734	50/50 Graphite/Talc Seed Lube, 8 lb. jug
73340918	Optional Dispensing Cap, 8 lb. jug (1/8 cup increments)

Singulator Kit Part No. 86994218E

- Includes new style singulator assembly, seed agitator, hardware and necessary installation instructions
- For all 1200 Series planters



Mini Hopper Bulk Fill Enhancement Kit Part No. 47532784

- For 1200PT, 1240, 1250 & 1260 planters
- An easy-to-assemble, quick-attach snorkel that slows down seeds to prevent clogging. Fills automatically for normal field operation and manually for plot planting.



Press Wheel Bearing Kit – Part No. B95270

- Application: 800, 900, 950, 955, 1200 planters
- Original equipment quality bearing
- Handy service package



Singulator Assembly Kit Part No. 47375935

- Complete kit, ready to install
- For all 1200 Series planters
- Provides more precise spool adjustment
- Reduced maintenance and longer spool life
- Requires new style seed agitator Part No. 326924A2E



Carrying Wheel Mud Scraper Kits

- For Early Riser® 1250 planters only
- Includes Support, hardware, scraper and necessary installation instructions.



NOTE! Holes may need to be drilled in the wing wheel standards to allow mounting.

CONFIGURATION	PART NUMBER	QTY.
12R30	84159439	6
16R30	84159439	8
24R30 w/11-22.5 wing tires	87675076	8
24R30 w/10.0-15 wing tires	87675076 84159439	4 4

SAFETY

At Case IH, we design and manufacture every piece of equipment with operator safety as a priority. As farm equipment has gotten larger, the size and weight of the equipment, coupled with the power of hydraulics and mechanical systems used to manipulate and control machines, makes a constant awareness of safety a foremost requirement of any operator. We also understand that planting time places added anxiety and stress on operators who know that the success of a full year is at stake every time they go to the field. However, hurrying never relieves the operator of their responsibility to operate the machine safely. Take a few minutes to review the Operator's Manual safety information before starting each year. The payback for your time should be a safer and more successful planting season.

Do not take shortcuts, thinking that an accident takes time to happen. Accidents can happen in seconds, too often leaving someone plenty time to think about how the accident could have avoided—while they heal.

GENERAL SAFETY RULES

1. Always remember that the Operator's Manual is first and always the "go to" resource when you have questions about how to operate your machine. The following information is a generalized review of Safety rules. Refer to the Operator's Manual for complete information.
 2. One of the main features of large planting equipment is the ability to quickly move from one farm to another, using public roadways. Take time to become familiar with the traffic laws in your locality and how they apply to your large planting equipment.
 3. When operating on public roads always use lights, flashers and turn signals for maximum visibility. Maintain a clean and visible Slow-Moving Vehicle sign on the rear of the machine.
 4. Be a good neighbor and pull over to let traffic pass if possible to avoid creating unnecessary delay and stress for other drivers.
 5. For best field performance and the most secure road transport, make sure the weight of the implement does not exceed the recommended towing capacity of the tractor being used. This is especially important in areas with high traffic and hills that increase the braking and stopping demands necessary to maintain safe control.
 6. Do not exceed the drawbar or towing capacity of the tractor. When transporting front-fold planters, empty seed and fertilizer boxes and tanks whenever possible to reduce tractor drawbar load and total planter weight.
 7. When transporting equipment, maintain safe maximum travel speeds to assure complete control, and the ability to stop in case of emergency. Refer to tractor and planter Operator's Manual recommendations for maximum transport loading and weight.
 8. Removing guards for service work is no excuse to leave guards off during operation. Guards are intended to protect operators and any other persons, and must remain intact and installed as originally designed.
 9. Review the Operator's Manual to identify and understand the use of service locks prior to starting service operations.
 10. Engage service locks for all service operations. Use jackstands or secure blocking when working under or around raised equipment. Never work on the planter without securely setting and locking service and transport locks in position and removing machine weight from the hydraulics systems.
- 
11. When servicing ground engaging components such as opening disks and firming points, use special care to avoid points and edges worn sharp during use.
 12. The design of modern planters places significant load on tires. Always keep tires inflated to the specifications published in your planter Operator Manual. Service tires carefully, observing Operator's Manual instructions and rules.
 13. Chemical application is often an integral part of planting. Use the utmost care to protect yourself, other people, and the environment from the effects of overexposure to agricultural chemicals.
 14. Follow label instructions for proper chemical mixing, handling and container disposal methods.
 15. Be familiar with safety procedures for immediate first aid should you accidentally contact chemical substances.
 16. Use the proper protective clothing and safety equipment when handling chemicals. Don't take chances-work safe.
 17. Chemicals are supplied with Material Safety Data Sheets (MSDS) that provide full information about the chemical, its effects on exposure, and first aid needs in the event of an emergency. Keep your MSDS file up-to-date and available for first responders in case of emergency.
 18. Observe and inspect all warning decals on the machine, and replace any decals that are damaged and unreadable.
 19. Never allow the machine to be raised or lowered while service is being performed. Numerous linkages are used to move and suspend components. Pinch points between linkage and other parts of the machine are inherent, and could cause injury to an unsuspecting worker if machine movement is initiated

SERVICE INSPECTION

TAKE FULL ADVANTAGE OF ITS CAPABILITIES

Have you, or did someone you know purchase a new planter in the last few years and continued to use it in much the same way as the planter it replaced? Many times operators do not fully realize and take advantage of modern features. As a result of not fully utilizing the planter's features, the owner may not be getting all the value from the money spent.

Many of the items suggested in this booklet can be completed by the owner when preparing for the season or the operator when starting a new field. Other adjustments, service procedures, or repairs might be more effectively completed by your dealer's trained service technicians.

MAINTENANCE CHOICES, BEING PREPARED FOR DEMANDING CONDITIONS

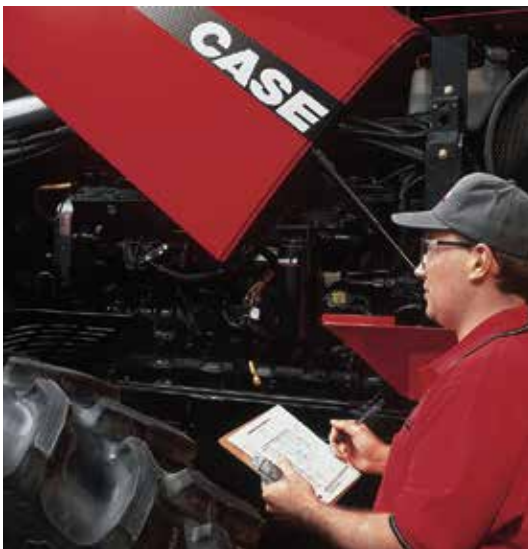

Ask your Case IH dealer about Customized Maintenance Inspections. It is a proactive way to be sure your planter will operate at its best possible performance when you need it.

Customized Maintenance Inspections include a visual and functional inspection of your planter. They can be used as a pre-season or as a post-season tune-up.

Benefits include:

- Increased productivity
- Less downtime during the season
- Lower operating costs
- Improved fuel economy
- Documented maintenance
- Service by Case IH-trained technicians
- Service with Genuine Case IH lubricants, filters, and parts

The combined advantages of Customer Maintenance Inspection services should result in a lower cost of ownership and higher resale values.



1200 SERIES EARLY RISER® PLANTER

INSPECTION CHECKLIST

CHECKLIST FOR YOUR “WALK AROUND” INSPECTION

	OK	Replace/ Adjust		OK	Replace/ Adjust
FIRMING WHEEL			TRANSMISSION (NON PT)		
1. Splits, Cracks	<input type="checkbox"/>	<input type="checkbox"/>	40. Chain Length/Stretch	<input type="checkbox"/>	<input type="checkbox"/>
2. Chevron Bars/Center Rib	<input type="checkbox"/>	<input type="checkbox"/>	41. Sprocket Alignment	<input type="checkbox"/>	<input type="checkbox"/>
3. Bearing	<input type="checkbox"/>	<input type="checkbox"/>	42. Sprocket Tooth Wear	<input type="checkbox"/>	<input type="checkbox"/>
4. Down Pressure Spring	<input type="checkbox"/>	<input type="checkbox"/>	43. Chain Tension	<input type="checkbox"/>	<input type="checkbox"/>
COVERING DISC			MAIN DRIVE WHEEL (NON PT)		
5. Diameter (min. 7.5 in.)	<input type="checkbox"/>	<input type="checkbox"/>	44. Chain Length/Stretch	<input type="checkbox"/>	<input type="checkbox"/>
6. Bearing and Cap Condition	<input type="checkbox"/>	<input type="checkbox"/>	45. Sprocket Tightener Alignment	<input type="checkbox"/>	<input type="checkbox"/>
7. Spring Condition	<input type="checkbox"/>	<input type="checkbox"/>	46. Sprocket Tooth Wear	<input type="checkbox"/>	<input type="checkbox"/>
SCRAPER			47. Chain Tension	<input type="checkbox"/>	<input type="checkbox"/>
8. Cleans properly (adjust/replace as needed)	<input type="checkbox"/>	<input type="checkbox"/>	48. Crossover Drive Pawl Alignment (1230/35, 1250/55 & 1260/65)	<input type="checkbox"/>	<input type="checkbox"/>
OPENER DISCS			49. Drive Line Alignment (Rigid Mount, Rigid Pull)	<input type="checkbox"/>	<input type="checkbox"/>
9. Diameter (min. 13.5 in.)	<input type="checkbox"/>	<input type="checkbox"/>	HYDRAULIC DRIVE (IF EQUIPPED)		
10. Runout (0.125 in. max.)	<input type="checkbox"/>	<input type="checkbox"/>	50. Hyd. Motor Oil Leaks	<input type="checkbox"/>	<input type="checkbox"/>
11. Clearance Between Openers (0 - 0.125 in. max.)	<input type="checkbox"/>	<input type="checkbox"/>	51. Shaft Alignment/U-joints	<input type="checkbox"/>	<input type="checkbox"/>
12. Bearing and Cap Condition	<input type="checkbox"/>	<input type="checkbox"/>	52. Drive Chain Tension	<input type="checkbox"/>	<input type="checkbox"/>
GAUGE WHEELS			MARKER DISCS		
13. Rubber/Rim Condition	<input type="checkbox"/>	<input type="checkbox"/>	53. Disc Condition	<input type="checkbox"/>	<input type="checkbox"/>
14. Clearance to Disc (0 - 1/8 in. max.)	<input type="checkbox"/>	<input type="checkbox"/>	54. Bearing Condition	<input type="checkbox"/>	<input type="checkbox"/>
15. Wobble Arm	<input type="checkbox"/>	<input type="checkbox"/>	PIVOT TRANSPORT (PT)		
16. Pivot Arm Pins	<input type="checkbox"/>	<input type="checkbox"/>	55. Pivot Lock Assembly	<input type="checkbox"/>	<input type="checkbox"/>
ROW UNIT PARALLEL LINKAGE			56. Pivot Roller/Adjustment	<input type="checkbox"/>	<input type="checkbox"/>
17. Linkage - wear	<input type="checkbox"/>	<input type="checkbox"/>	GRANULAR CHEMICAL (IF EQUIPPED)		
FURROW FORMING POINT			57. Chain Mechanism	<input type="checkbox"/>	<input type="checkbox"/>
18. Wear Limit using Gauge 1958225C3	<input type="checkbox"/>	<input type="checkbox"/>	58. Chain Tension	<input type="checkbox"/>	<input type="checkbox"/>
SHOE AND DEFLECTOR			59. Hopper & Lid Condition	<input type="checkbox"/>	<input type="checkbox"/>
19. Shoe Alignment to Opener Discs	<input type="checkbox"/>	<input type="checkbox"/>	60. Feed Rolls	<input type="checkbox"/>	<input type="checkbox"/>
20. Excessive wear at Bottom and Side of Shoes	<input type="checkbox"/>	<input type="checkbox"/>	61. Discharge Tube	<input type="checkbox"/>	<input type="checkbox"/>
DEPTH CONTROL			LIQUID FERTILIZER (IF EQUIPPED)		
21. Row Units Zeroed (if parts were replaced)	<input type="checkbox"/>	<input type="checkbox"/>	62. Tank, Filter and All Lines Clean	<input type="checkbox"/>	<input type="checkbox"/>
22. Down Pressure Spring	<input type="checkbox"/>	<input type="checkbox"/>	63. Orifices Installed and Clean	<input type="checkbox"/>	<input type="checkbox"/>
SEED METERING SYSTEM			64. Pump Dampener Pressure and Oil Level	<input type="checkbox"/>	<input type="checkbox"/>
23. Seed Meter Cover (wear points visible, deformation)	<input type="checkbox"/>	<input type="checkbox"/>	65. Section Valves Clean and Function Coulter Wear/Damaged	<input type="checkbox"/>	<input type="checkbox"/>
24. Seed Disc (wear slot, seed holes, flatness)	<input type="checkbox"/>	<input type="checkbox"/>	66. Calibrate	<input type="checkbox"/>	<input type="checkbox"/>
25. Agitator (condition, damage)	<input type="checkbox"/>	<input type="checkbox"/>	ELECTRICAL		
26. Singulator (lever, spool dia. minimum 1.1 in.)	<input type="checkbox"/>	<input type="checkbox"/>	67. Wire Harnesses/Tie Straps	<input type="checkbox"/>	<input type="checkbox"/>
27. Brush Condition (Curved & Straight)	<input type="checkbox"/>	<input type="checkbox"/>	68. Seed Tube Sensor (function/LED), clean	<input type="checkbox"/>	<input type="checkbox"/>
28. Meter Coupling Drive (operation, engagement)	<input type="checkbox"/>	<input type="checkbox"/>	69. Hopper Seed Level Sensor	<input type="checkbox"/>	<input type="checkbox"/>
29. Seed Tube condition	<input type="checkbox"/>	<input type="checkbox"/>	70. True Ground Speed Sensor (approx. 0.1 in. clearance)	<input type="checkbox"/>	<input type="checkbox"/>
30. Vacuum Lines (condition, obstructions)	<input type="checkbox"/>	<input type="checkbox"/>	71. Monitor (operation, functionality)	<input type="checkbox"/>	<input type="checkbox"/>
31. Vacuum Gauge Zero Adjustment	<input type="checkbox"/>	<input type="checkbox"/>	AFS ACCUROW (PNEUMATIC)		
32. Vacuum Gauge Filter (back side of gauge)	<input type="checkbox"/>	<input type="checkbox"/>	72. Air Compressor Filter (clean or replace)	<input type="checkbox"/>	<input type="checkbox"/>
PNEUMATIC DOWN PRESSURE			73. Air Tank (drain, inspect)	<input type="checkbox"/>	<input type="checkbox"/>
33. Air Compressor Filter (Clean or Replace)	<input type="checkbox"/>	<input type="checkbox"/>	74. Air Line (leaks, damage, etc.)	<input type="checkbox"/>	<input type="checkbox"/>
33. Air Tank (Drain, Inspect)	<input type="checkbox"/>	<input type="checkbox"/>	75. Row Clutch Function (clean if needed)	<input type="checkbox"/>	<input type="checkbox"/>
34. Air Lines (Leaks, Damage, etc.)	<input type="checkbox"/>	<input type="checkbox"/>	76. Row Clutch Lubrication	<input type="checkbox"/>	<input type="checkbox"/>
ROW SEED HOPPER			OTHER/ATTACHMENTS		
35. Hopper Condition	<input type="checkbox"/>	<input type="checkbox"/>	77. Frames	<input type="checkbox"/>	<input type="checkbox"/>
36. Hopper Lid, Tether Strap	<input type="checkbox"/>	<input type="checkbox"/>	78. Welds	<input type="checkbox"/>	<input type="checkbox"/>
BULK FILL (OPTION - PIVOT TRANSPORT (PT) + FFT)			79. Drivewheel Pressure/Inflation	<input type="checkbox"/>	<input type="checkbox"/>
37. Tank Lid Seal	<input type="checkbox"/>	<input type="checkbox"/>	80. Hyd. Hose Routings	<input type="checkbox"/>	<input type="checkbox"/>
38. Hyd. Fan motor (oil leaks)	<input type="checkbox"/>	<input type="checkbox"/>	81. Hydraulic oil reservoir level (PTO Pump Only)	<input type="checkbox"/>	<input type="checkbox"/>
39. Air Leaks - hoses, induction box	<input type="checkbox"/>	<input type="checkbox"/>	82. PTO Gearbox oil level (1240 PTO pump only)	<input type="checkbox"/>	<input type="checkbox"/>

SERVICE INSPECTION

REMOVING THE PLANTER FROM STORAGE

1. Clean hydraulic hose couplers before connecting to the tractor.
2. Make sure tires are properly inflated before moving the planter.
3. Remove protective grease and clean exposed cylinder rods.
4. Carefully raise the planter, making sure settling during storage, or other closely-parked equipment does not result in interference when raising and moving the planter.
5. Make sure seed disks are returned to matching meter housings when re-installed.
6. Inspect the entire planter for signs of rodent or other damage. Check hydraulic hoses and wiring harnesses for proper routing, and tie strap as needed.
7. Re-install drive chains.
8. Lubricate all grease fittings. Do not over-grease fittings lubricated when the unit was put in storage.
9. Cover bulk fill hopper bottom with powdered graphite
10. Cover seed disk with graphite
11. Work powdered graphite into singulator spool pins
12. Clean seed tubes and seed sensors
13. Close AccuRow or Pneumatic Down Pressure drains if applicable.
14. Read the Operator's Manual for both the planter and display operation



1200 SERIES EARLY RISER® PLANTER

TRACTOR/PLANTER HOOKUP



Several important factors must be considered when matching the tractor to the planter. The Tractor/Planter Preparation section of the Operator's Manual lists specific requirements for your planter. General factors are:

- Minimum tractor PTO horsepower
- Minimum tractor weight and balance
- Minimal number of remote hydraulic valves
- PTO compatibility with planter hydraulic pump, if equipped
- Adequate 12 volt electrical system capacity
- 3-point hitch requirements
- Tractor tread width adjustable to row spacing

Some specific details that apply to general tractor/planter compatibility requirements include:

- Tractor horsepower and weight must be adequate to maintain control of the planter in the field and transport situations. This is especially important when operating on hilly or unstable soil when additional control is required.
- Planters are equipped with several hydraulic motors that require low back pressure case drain returns to the tractor. Low pressure is defined as less than 25 PSI under full-flow conditions. Refer to your tractor Operator's Manual for correct low-pressure return connections for your tractor.
- A warning tag (A) on the case drain hose reminds the operator that incorrect connection of the case drain may damage the vacuum fan motor. Motor failures due to improper case drain connection are not covered by warranty.
- When using a hydraulic PTO pump to power planter vacuum and bulk fill fans, refer to specific tractor installation instructions for PTO pump torque restraint kits.
- Tractor 3-point hitch adjustments should be set according to planter Operator Manual instructions. For example, sway adjustment will vary between hitch-mounted toolbar planters, and a drawn planter using the 3-point hitch quick coupler connection to the tractor.
- Electrical system requirements include the standard seven-pin connector socket for safety lighting, and to power the planter hydraulic system cooling fan, if equipped. In addition, tractor monitor or AFS system wiring may be required, according to installed options.
- Tractor requirements vary widely depending upon the size of planter and type of hitch arrangement. Always refer to the Operator Manual for information pertaining specifically to your planter.



When hookup is complete, thoroughly inspect the routing of all hoses and electrical harnesses between the tractor and planter.

- Steer the tractor/planter combination through complete right and left turns, raise and lower the tractor or planter hitch while observing routing to assure no interference develops during operation and maneuvering.

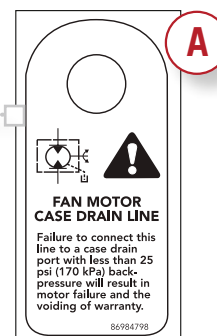

OPERATION

LEVELING THE PLANTER

Planter row units must be set to operate level front-to-back when operating in the field.

- Adjustments should be made with the planter in a level area of a field prepared for planting.
- Planter unit down-pressure adjustments should be set according to planting conditions.
- When the planter is lowered to the operating position, the toolbar should be level, and the parallel linkage arms level between the toolbar and planter row units.

Note: Measure the distance between the ground and the front and rear of the toolbar. The distance should be the same: **508 mm (20 in.)**. If not, adjust the clevis in the hitch to obtain the **508 mm (20 in.)** at both locations.



GENERAL PLANTING TIPS

Several important factors must be considered when planting. General factors are:

- Do not lower the planter to planting position while stationary. This may cause plugging at the seed shoe. Always be moving forward when the planter is lowered to planting position.
- Dig often to check seed depth and seed spacing accuracy.
- After lowering the planter, place the frame control remote valve in float to allow the markers to float.

Check tractor hydraulic flow adjustments for each planter function run direct from the tractor (Vacuum Fan(s), Seed Drive (if equipped), Liquid Fertilizer, & Bulk Fill) after reaching operating temperature. **Do not** set the flow levels to 100% and leave. Flows levels should be set just above the required amount to reduce the potential for overheating and power consumption.

PLANTING WITH A HYDRAULIC DRIVE PLANTER

Hydraulic drive planters require different operating techniques than ground drive planters. Follow these tips to have a successful planting season.

- Use the 'Planter Systems' button (v27.* software and after) to start the necessary systems (vacuum, bulk fill, seed & liquid, plus prime the meters) to begin planting...with one button push! It's never been easier!
- Also utilize "Prime Control" if starting to plant with the planter in the ground and starting at 0 mph. The planter does not automatically start planting until 1 mph of ground speed. A planting gap could be seen, if prime control is not used.
- Maintain constant and high enough engine RPM levels to keep high quality planter operation. This engine RPM is typically between 1800-1900 engine RPMs. See the tractor operator's manual.
- Avoid sudden changes in ground speed to keep consistent seed spacing.
- When stopping lift the planter out of the ground or use the "Master Control" button to stop the seed drives before stopping to assure consistent seed spacing.

Please reference the "Working Operations" section of the planter Operator's Manual for more details.

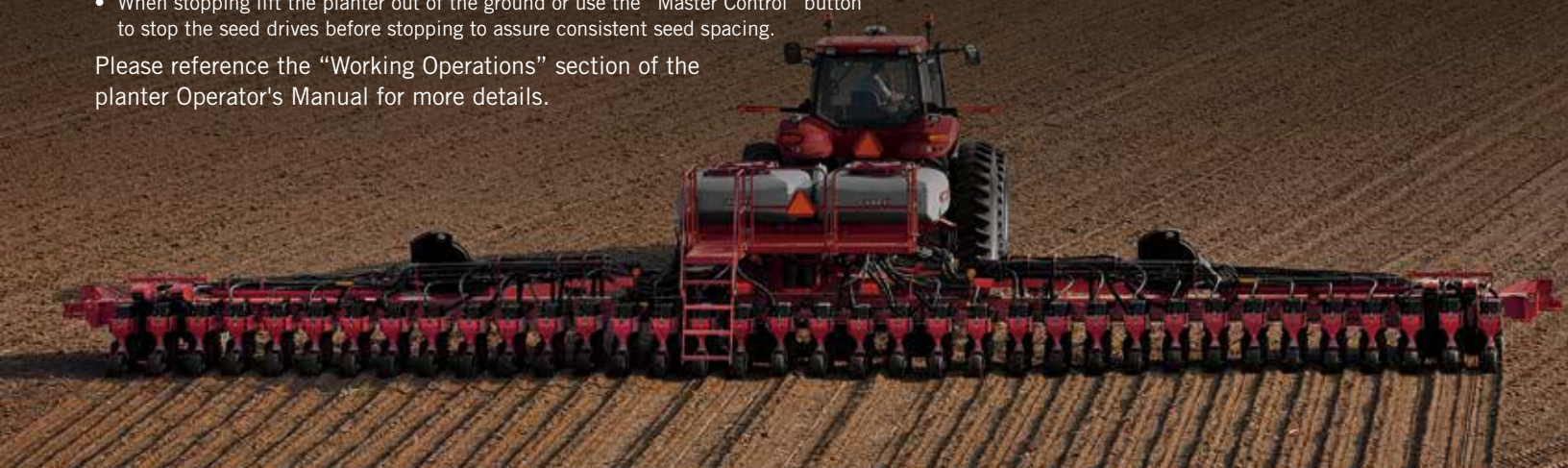
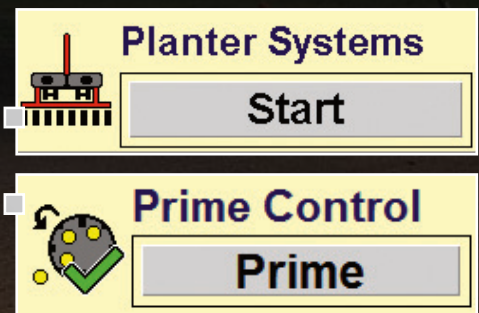

MAINTENANCE



DAILY MAINTENANCE

Daily maintenance on Case IH planters is limited to a few simple lubrication and component checks.

- Grease points should be identified by reviewing the lubrication section of your planter Operator Manual.
- Units equipped with a PTO fan drive have a separate planter mounted oil reservoir. The oil level should be confirmed to be at the proper level; the oil cooler checked for debris that could impair air flow, and fan operation verified to assure proper system cooling.
- Numerous drive chains are used on planters, and should be lubricated using Case IH chain lubricant ZAD-1.
- Check all air intake screens on vacuum or bulk hopper fan inlets.
- Lubricate all frame pivots. Lubricate drive couplers and driveshaft grease fittings according to Operator Manual specifications.

VERIFYING PLANTER PERFORMANCE AND “AS REQUIRED” MAINTENANCE

Advanced Seed Meter and Early Riser row unit maintenance is described in the Operator Manual as “as required” service functions.

- Basically, this means that units can be operated without need for specific maintenance checks as long as meter function is to standard, and seed placement and seed furrow opener performance is satisfactory.
- The key to defining “as required” is quite simply to “get out and dig” behind the planter.
- Throughout the day, stop and open the seed trench behind the planter on varying rows to perform a full planter inspection at least once per day. **This is especially important when starting each season; or when making planter changes or adjustments.**
- Maintain enough down pressure to prevent row unit bounce and potential poor seed placement.
- Look for seed trench opening disks (A, B) and firming point (C) depth. Seed depth should be checked from the press wheel impression to the seed. Do not measure from the gauge wheel impressions, or the surface of the soil between the row unit gauge wheel tracks.
- Check seed spacing (D) and placement to confirm seed meter accuracy and setting.
- Confirm covering disk action and seed trench closure (E).
- Verify press wheel function (F).

The outcome of these inspections will determine if adjustment is necessary on meters or row units.

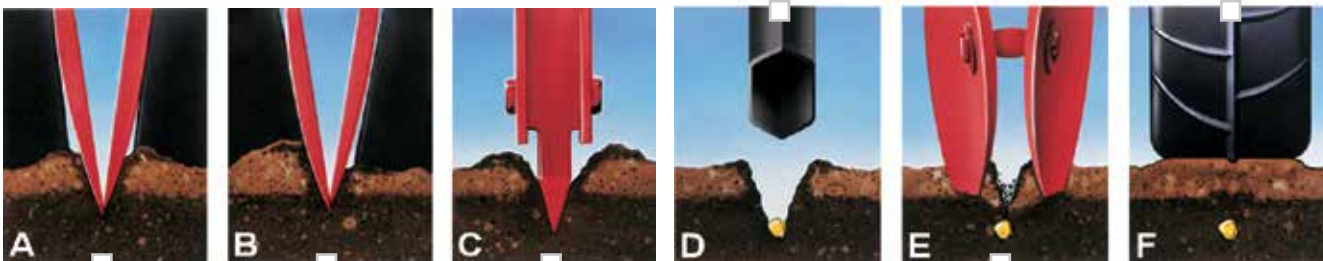

MAINTENANCE

ADVANCED SEED METER INSPECTION

The simple design of the Case IH Advanced Seed Meter greatly reduces maintenance demands when compared to other seed meters. With just a few simple steps, the meter can be inspected and worn parts replaced to maintain the efficiency and accuracy of the meter.

Begin by removing the seed hopper and meter from the row unit.

- Disconnect and inspect the main vacuum hose and its connection to the meter.
- Three latches hold the meter cover to the meter housing. Remove the cover and inspect the surfaces on the cover.
- Six triangular wear indicators are molded into the cover. Inspect the indicators for wear, and replace the cover if any indicators are worn beyond recognition.

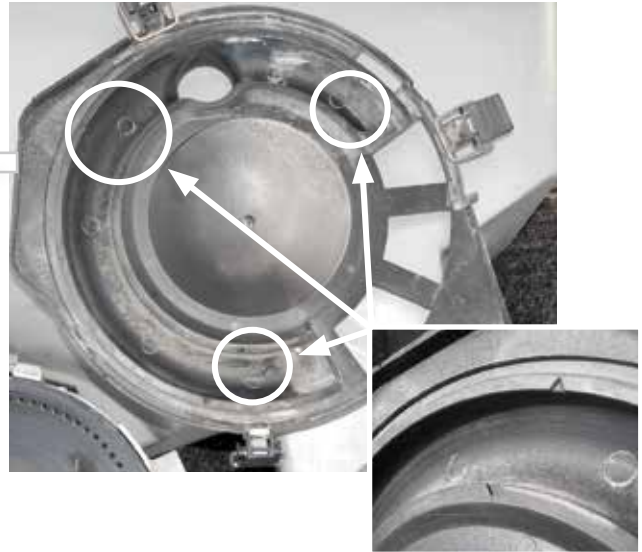

The seed disc is manufactured with wear indicator slots which become shallow as the disc wears.

- Replace the disc when the surface is worn to the bottom of the slots and the slots are no longer visible.
- When replacing the disc make sure adhesive labels are removed from the outer area of the disc at least 1.5 in. back from the seed holes on either side of the disc. Adhesive labels can affect singulator adjustment and may result in variations in seed spacing.
- Also inspect the seed holes, and replace the disc if any holes are worn out-of-round.

It is normal for seed discs to develop circular grooves as the disc wears in and mates to the housing. **Discs must always be returned to the same meter housing for optimum life and performance.**

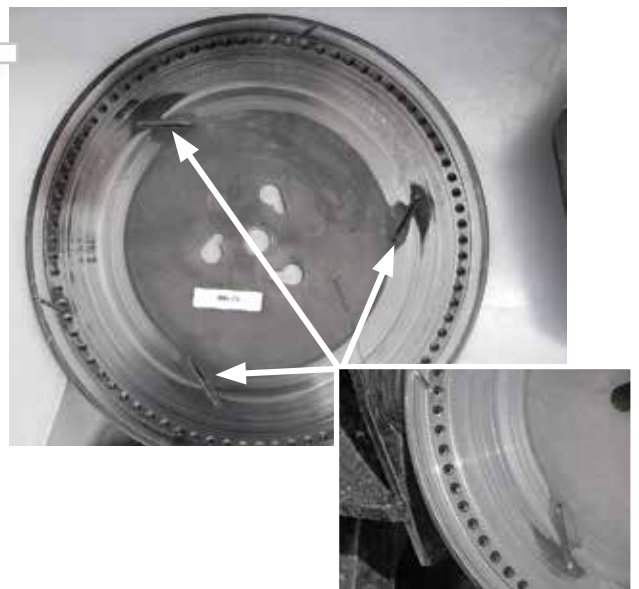

Rotate the singulator dial to make sure the spool assembly moves freely in its tracks.

- Remove debris with compressed air if necessary to ensure free movement.
- Do not use chemical solvents to clean the singulator.
- Check the singulator arms and spools for freedom of movement and rotation.
- The singulator spools are manufactured with a wear indicator groove "A" around the outer edge.



MAINTENANCE

ADVANCED SEED METER INSPECTION (CONTINUED)

- Replace the spool when it is worn to the bottom of the groove.
- Singulator spools are 1.17 in. diameter when new.
- Lubricate the singulator spool bearing surfaces with dry powdered graphite.

1. Wear Groove
2. Worn Spool

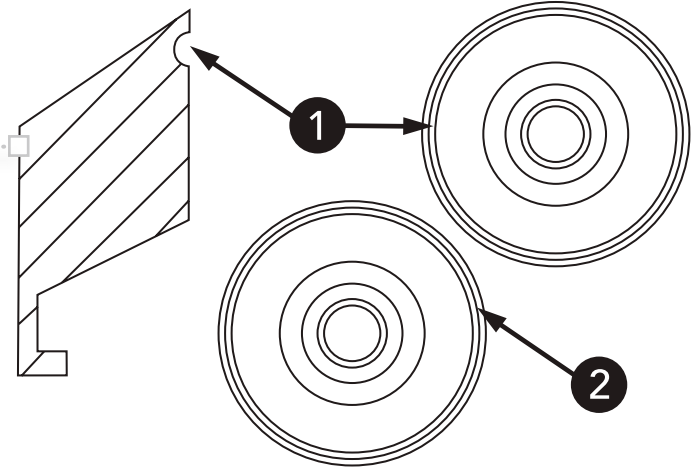

Other seed meter checks:

- Check for debris in the seed meter screen and behind singulators.
- Inspect the agitator for any signs of wear, breakage or permanent distortion.
- Turn the disk rotor drive to make sure it turns freely.
- When all components are removed from the meter housing, wash the meter housing with soap and water to remove debris.
- Use only dry powdered graphite to lubricate the singulator components.
- Clean debris from the meter brushes. The brushes will naturally become deformed in operation, which is not a cause for replacement. Replace the brushes only if leakage occurs from the meter housing.
- CHAIN DRIVE ONLY - Check the drive coupler pawls to assure they rotate freely and completely to allow full engagement and disengagement of the disk drive rotor.



Check the seed tube and sensor for signs of debris which would affect seed movement, placement and sensing.

- Roughness in the seed tube can affect seed spacing patterns, and should be repaired by replacing the tube.
- Check for wear at the bottom of the tube where seed enters the seed trench.
- Clean seed sensors with soap and water, or Seed Tube Cleaning Brush Part Number 346290A, available from your Case IH dealer.

MAINTENANCE

ADVANCED SEED METER INSPECTION (CONTINUED)

Refer to the Operator's Manual for complete inspection and part replacement procedures.

- A key element in achieving long life and good meter performance is to always assure that seed disks are returned to their original meter housings. Wear patterns will develop during operation. If seed disks are mixed, new wear patterns will accelerate disk wear and could result in premature replacement. Meter performance issues may develop due to variations in the operating fit from one row unit to another.
- Number disks and meter housings to assure disks are always returned to the same housing.



ACCUROW – PNEUMATIC CLUTCHES

Service requirements for the AccuRow system are minimal. The row clutches are disengaged by air pressure supplied by an onboard compressor. Prescribed air system service such as draining condensation from reservoir tanks and cleaning or replacement of the air filter element will help to assure trouble-free operation.

Refer to the Operator's Manual for specific service details. The primary service points are:

- Lubricate the row clutches every 100 hours. Remove the Phillips-head screw from the lube port and spray a 1 second blast of DRY SILICONE into the port.

IMPORTANT: DO NOT use petroleum-based solvents or lubricants in the clutch lube port.

- Remove the air hose, and lubricate the clutch piston with one drop of SAE 10W30, or air tool oil.
- At the end of the season remove the covers from the AccuRow clutches and blow any accumulated dust out of the clutch with compressed air. Excessive dust buildup in the clutch will cause it to slip under load.
Note: A rubber cover (P/N - 47457493 is available to cover and protect each clutch from dust and moisture.
- Air reservoirs should be drained daily. When operating in high humidity conditions, more frequent service is suggested.
- Air Compressor filter element should be blown out daily or every 10 hours of operation. Filter element should be replaced every 200 hrs or once per season. The filter element is part number 47454058. **Note:** The filter intake screen should be positioned towards the ground when re-installing the filter element cover.

EARLY RISER ROW UNIT INSPECTION

A walking beam suspension between the two gauge wheels and the row unit opener frame allows one gauge wheel to pass over a rock or clod.

- Only raises the opener one half the distance to maintain a more consistent planting depth.
- Gauge wheels are pulled by arms mounted from the front of the row unit. Wheels move over obstructions more easily than “pushed” gauge wheels.



MAINTENANCE

EARLY RISER ROW UNIT INSPECTION (CONTINUED)

The seed furrow is created by the Early Riser Row Unit starting with two staggered 14-inch opener disks.

- The trailing disc follows behind and slightly to the side of the leading disk to open the trench and move moist soil to the surface.
- Check the distance between the opener disks at the closest point. Distance between the openers should be shimmed to **0 - 3.1 mm (0 - 1/8 in)**.
- Soil that is raised to the surface by the opening disks is held in place at the edge of the seed furrow by grooves on the edge the gauge wheels, next to the disk.

A slight “W”-shaped formation at the bottom of the trench is made up of loose soil.

- A firming point (A) finishes the trench by forming the soil at the bottom of the trench into a consistent V-shape for optimum soil-to-seed contact and germination.
- The firming point should be replaced when it no longer conforms to the shape of the 1958225C3 firming point tool, available from your Case IH dealer.

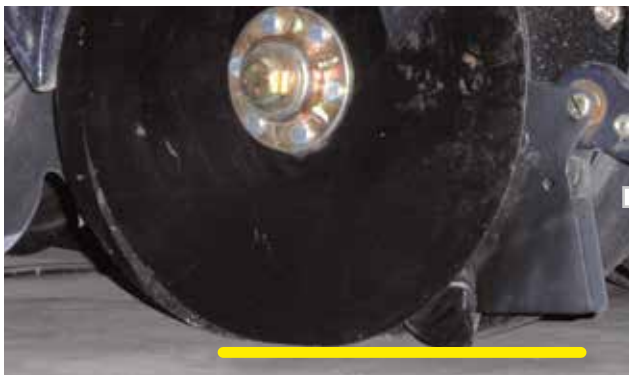

When servicing ground-engaging components, use care to avoid injury on parts worn sharp by contact with the soil.

- Refer to the Operator's Manual maintenance section for the proper procedures for replacing components.
- Opener disks should be replaced when they are worn to a 13-1/2 in. diameter.
- Inspect disk scrapers.
- Scrapers are not adjustable, and should be replaced when they are no longer able to keep disks clean in your soil and planting conditions. Rotary scrapers are available from your parts department.
- Disks and firming points should be replaced **in sets** to maintain an even depth and soil contact characteristics, and to promote even wear patterns.
- Check each side of the seed shoe for wear. The seed shoe helps retain the sides of the seed trench until after the seed is dropped into the seed trench. Replace the seed shoe if a notch is worn in the bottom of either side of the seed shoe.

MAINTENANCE

Checking the row unit zero setting. The zero setting should be checked when any of the following occur:

- New parts are installed on the gauge wheel and adjustment system.
- The opener disks and firming point are replaced.
- A row unit is not planting at the same depth as the others when set at the same setting.
- During preseason preparation.

To check and adjust the zero setting:

1. Place the planter on a hard/level surface (preferably a concrete pad).
2. Lower the planter row units until the parallel links are parallel to the ground.
3. Turn the depth control handle on the rear of the row unit until the indicator is at ZERO.
4. Check the clearance between the firming point and the level surface. The correct clearance should be 0.79 mm (0.030 in.).
5. If the clearance is larger than 0.79 mm (0.030 in.), lift the planter and insert a 1/4 x 2 3/4 in. pin in the hole of the wobble bracket.
6. Lower the planter so the parallel links are level and turn the depth adjustment handle till the clearance of 0.79 mm (0.030 in.) is reached.
7. Loosen the scale retaining screws and move the scale align the Zero position with the "0" on the indicator.
8. Remove the headed pin from the wobble bracket.
9. Adjust the row units to the desired depth using the depth adjustment handle.

Check closing disks for a minimum outside diameter.

- Replace closing disks when they are worn to a diameter of 7.5 inches or are damaged.



The Pneumatic Down Pressure system has few maintenance requirements.

- Draining accumulated condensate water from the system is the primary service requirement.
- Check the following components of the system for leakage with soapy water if system leak-down is occurring:
 - system pressure gauge - Schrader valve
 - three way valve(s)
 - threaded fittings
 - tubing press fittings
 - pneumatic springs on row units
- On AccuRow-equipped planters with In-Cab Pneumatic Down Pressure adjustment, a common air system is used for AccuRow and Pneumatic Down Pressure.
 - AccuRow maintenance will provide necessary service for Pneumatic Down Pressure system

Refer to the Operator's Manual for the specific planter for complete details.

On planters with hydraulically-driven seed meters, check ground speed sensors on the wheels for debris or missing teeth.



- Sensor "sprockets" should operate a consistent distance from the sensor of 0.040-0.160 inch while the wheel is turned, for accurate speed indications.
- Make sure speed sensor harnesses are properly routed and secured.

MAINTENANCE



BULK HOPPER INSPECTION

Some simple checks should be performed on bulk hopper systems to assure proper operation.

- Cover gasket condition and seal integrity
- Remove debris from the bulk seed fan screen
- Clean bulk fill inductor box
- Inspect inductor box seals

If the cover gasket does not appear to contact the cover evenly, adjustment of the hinges and latches may be helpful in maintaining a more airtight seal.

BULK FILL SYSTEM TROUBLESHOOTING DIAGRAM (MY2002-MY2012)

SEED NOT FLOWING OR LOW SEED FLOW TO THE MINI-HOPPER.

Turn the bulk Fan OFF and verify by removing hose from the mini-hopper – seed level should be full to the top of the screen or bottom of the seed deceleration elbow (MY12 & after).

Check that fan speed selected is a recommended speed and that fan is operating.

Check that seed gate is in the OPEN position.

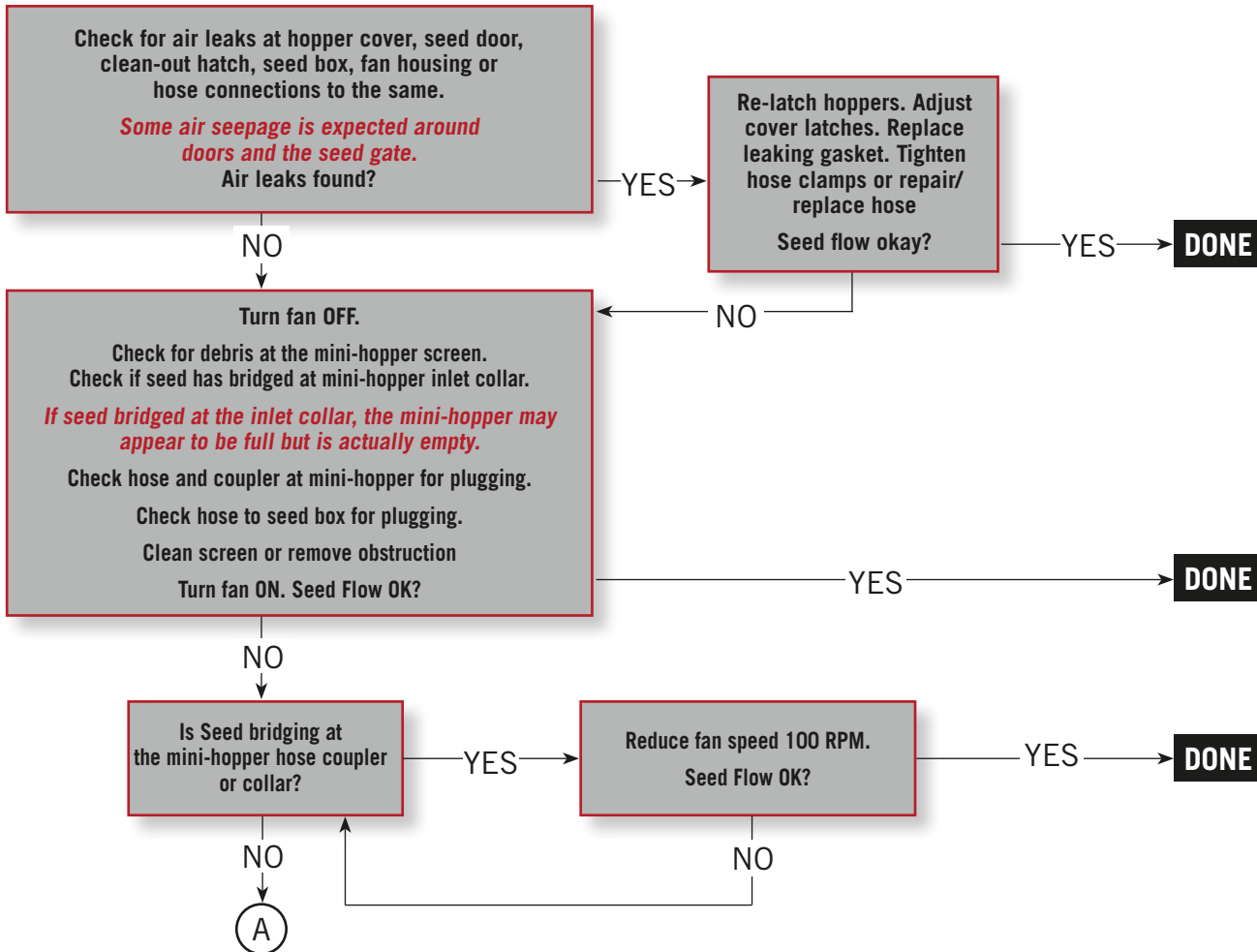

MAINTENANCE

BULK FILL SYSTEM TROUBLESHOOTING DIAGRAM (MY2002-MY2012) CONTINUED

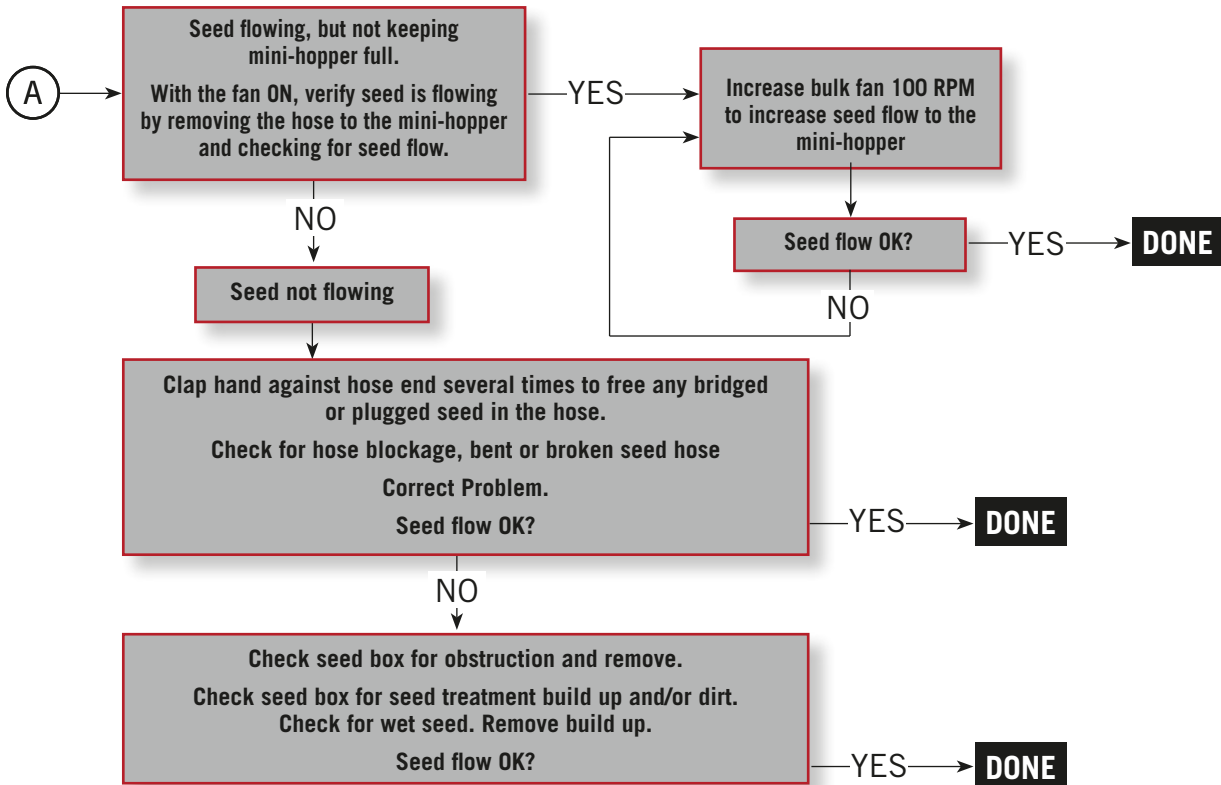

NEW ISSUE

Mini-hoppers on OUTER row units not staying full of seed

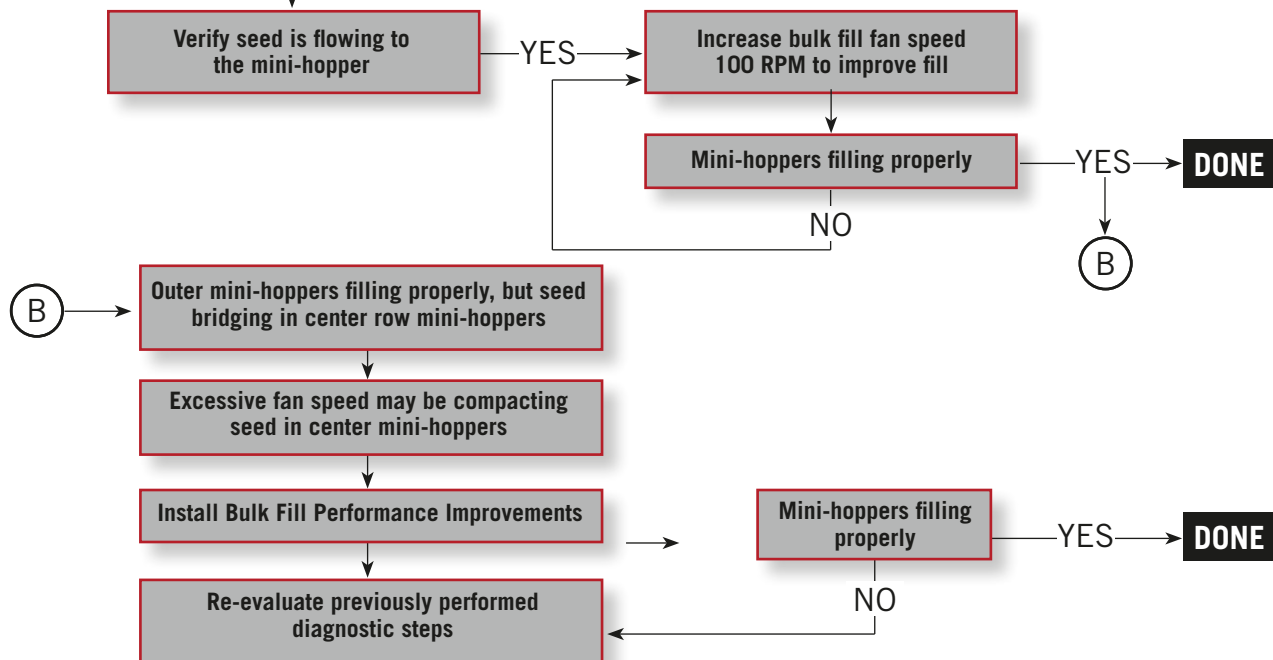

MAINTENANCE

EARLY RISER® 5 SERIES BULK FILL SYSTEM TROUBLESHOOTING DIAGRAM

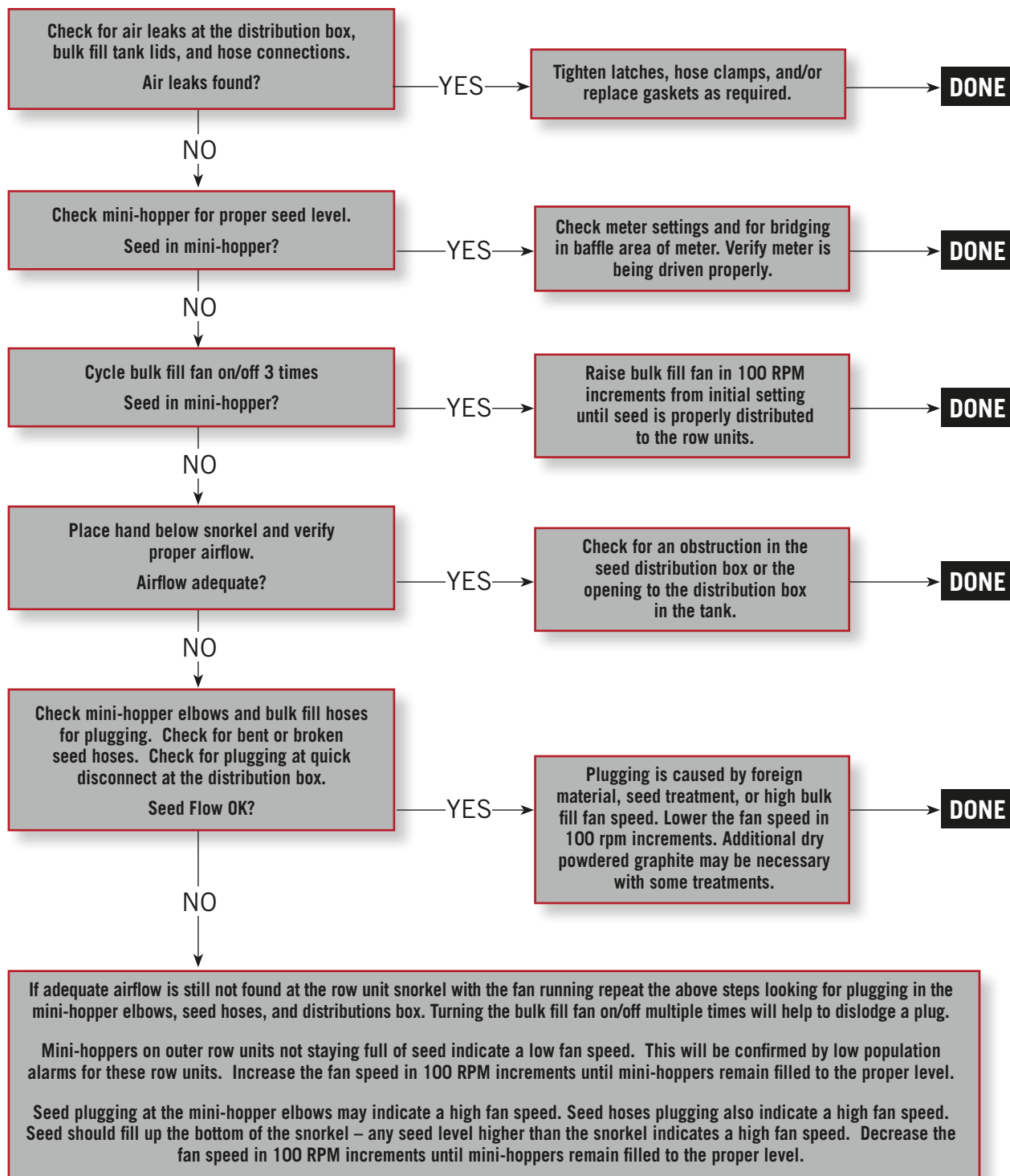

NOTE: Additional dry powdered graphite may be necessary when using seed coated with treatments.

MAINTENANCE

BULK FILL PERFORMANCE IMPROVEMENT (MODEL YEAR 2002-2010)



A new kit is available to improve the performance of the Model Year 2002-2010 bulk fill system. The result is more balanced and reliable seed delivery.

Part No. 47532784

An easy-to-assemble, quick-attach snorkel that slows down seeds to prevent clogging. Fills automatically for normal field operation and manually (up to 1 gallon of seed) for plot planting.



The new new mini-hopper, found on 5 series planters and in this kit have alignment pegs and a center boss to properly locate it on the row unit frame. Ensure the alignment pegs of the mini-hoppers are fully located in the row unit frame holes before latching. This will prevent damaging the mini-hopper.



LIQUID FERTILIZER (IF EQUIPPED)

The Case IH fertilizer system uses a hydraulically driven diaphragm pump, in-line filter, flowmeter (feedback), pressure gauge, recirculation or relief valve, section control valves, and applicator orifice or injector w/ check valve to control the application rate. The pump supplies sufficient flow (gpm, l/min) to supply the needs of the flowmeter and the recirculation circuit. Pump flow rate is controlled by the AFS system, based on the desired application rate input by the operator. These components require regular checking and maintenance to assure accurate application rates throughout the entire planting season.

Some specific maintenance items include:

- Check that the tank(s), filter, and all fertilizer hoses and lines are clean and free of blockage and damage.
- Verify all hydraulic fittings are secure and tight.
- Orifices (1) and check valves must be installed and free of debris. (clean screen, if installed). Consult a local fertilizer supplier or use the orifice selection chart found in the operator's manual. Orifices are available from your Case IH dealer.
- Check the pump dampener pressure. The dampener in the fertilizer pump must be charged with an air pressure of approx. 10 psi (about 20% of the normal operating system pressure). Use a tire gauge to check the air pressure at the air valve (2). **DO NOT OVER-CHARGE THE DAMPENER!** Erratic rate control or no flow will occur.
- Check pump oil level. Use the sight glass on the pump (3) to monitor oil usage. Replenish whenever the level falls below the midway point on the glass. Use high grade, non-detergent, SAE 30 weight oil (CNH Tutela Hydraulic Fluid, Part No. 87299774) to refill. **Note:** Extreme hot to cold variations may cause the pump to weep oil. Oil level should be checked regularly
- If equipped, check all coulter for wear or damage. Lubricate any grease zerks.
- Perform the Liquid Fertilizer Calibration Procedure to assure proper liquid fertilizer rates.

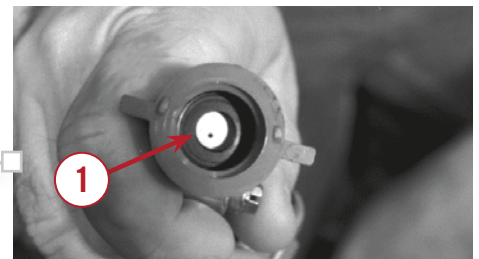

Orifice Part Numbers

#29 86983914	#52 86983919
#35 86983916	#65 86983920
#40 86983918	#89 86983921

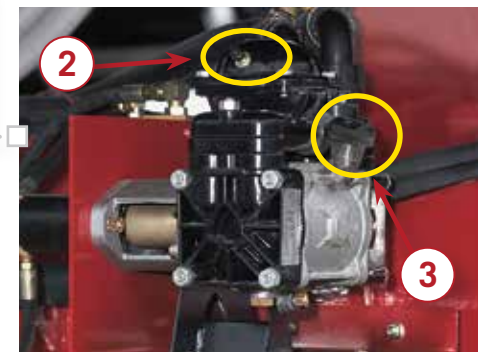

MAINTENANCE

IN-FURROW LIQUID FERTILIZER OR INSECTICIDE APPLICATION

Recent trends toward placement of in-furrow application of liquid fertilizer or insecticide has resulting in some cases where seed spacing is affected. Case IH does not currently offer an in-furrow application system, so third-party or owner fabricated parts are used to place product in the seed trench. Application equipment is often attached to the seed shoe portion of the opener, and may affect seed placement in either of several ways:

- Seed may be dragged by the attachment.
- Residue collects on the attachment, altering placement accuracy.
- Product residue may interfere with seed travel from the shoe and into the trench.

Planter monitors do not display seed placement, so operators must dig behind the planter to verify placement accuracy.

TWO OPTIONS FOR APPLYING LIQUID PRODUCT IN-FURROW WITH THE CASE IH ROW UNIT

The Early Riser row unit can be used successfully with in-furrow liquid product by adhering to the following guidelines:

- Be careful to keep liquid residue from collecting inside the seed shoe or seed tube. If residue collects on either of these parts, the spacing performance of your planter will be affected. The product applicator tube must also be kept out of the path of seed delivery to the furrow.
- Keep the tip of the fertilizer tube at least one and one-half inch above the bottom of the seed shoe and at least $\frac{3}{4}$ inch behind the rear corner of the seed shoe.
- Never use a spray applicator tip when placing liquid fertilizer in-furrow.

Your Case IH dealer has technical resources with more detailed information on this topic, and should be consulted for further assistance.

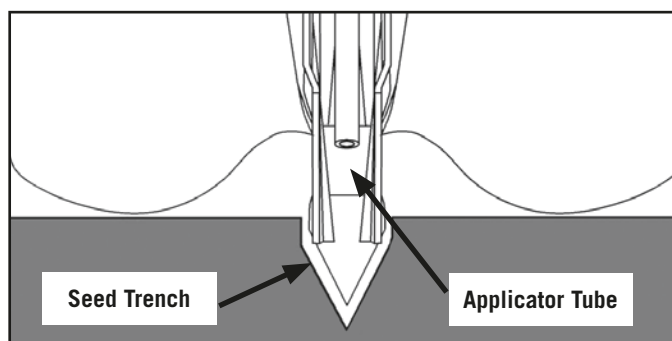
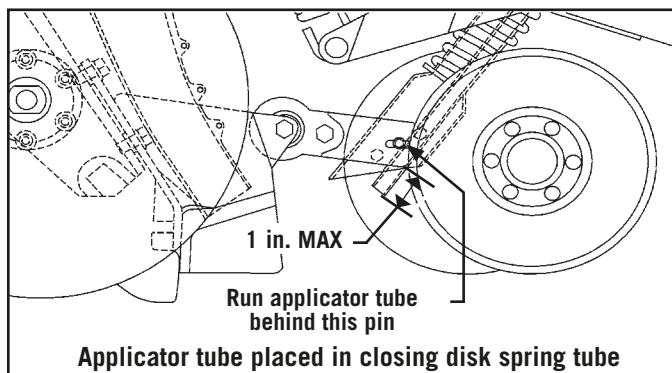
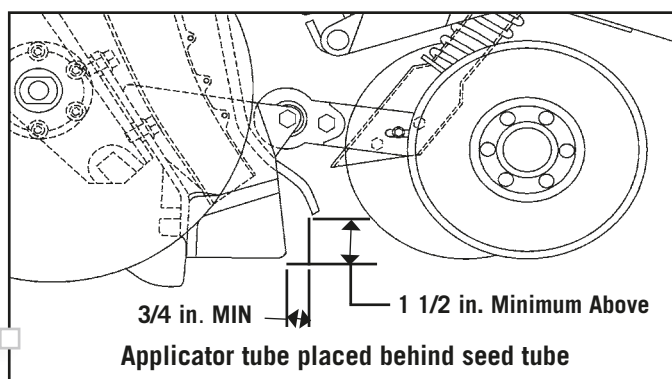
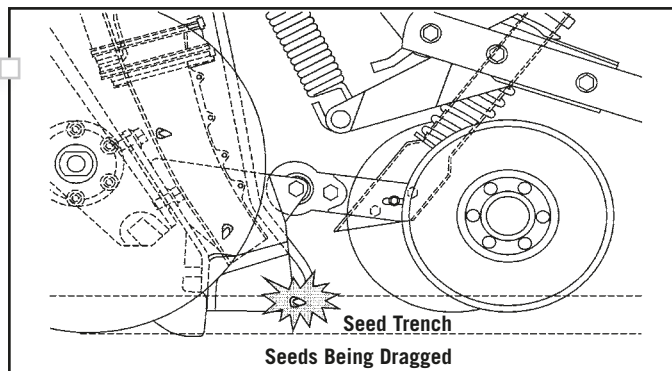

ADJUSTMENTS

SEED LUBRICANT

GRAPHITE

Case IH Iron Gard Graphite seed lubricant is recommended for all 1200 Series Early Riser planters to provide lubrication for the seed delivery and seed meter components. For best coverage and performance with bulk fill, apply graphite seed lubricant while filling the seed hopper either with an applicator on the seed tender or as the seed enters the tank.

50/50 GRAPHITE/TALC MIX

- Many coated seeds are somewhat sticky
- Graphite seed lubricant alone may still result in some seed flow issues
- Talc may improve flow characteristics by bonding to the sticky coating.
- Excess talc can result in buildup on meter and seed contact components
- 50/50 ratio results in most uniform seed flow performance with minimal talc buildup.

For best coverage and performance with bulk fill, apply the 50/50 graphite/talc mix seed lubricant while filling the seed hopper either with an applicator on the seed tender or as the seed enters the tank.

- Basic ratio is 1/8 cup per two bushels
- Use talc sparingly in humid or damp conditions (talc absorbs moisture and may result in seed flow issues)

Refer to the planter Operator's Manual for lubricant application rates for new planter hoppers and first fill. Some other helpful hints assure meter performance:

- Vacuum should be set only as high as necessary to hold seeds to the seed disk.
- Excessive vacuum accelerates seed disk and seed meter housing wear.
- Excessive vacuum makes singulation more difficult, and requires more oil flow and power to operate the fan. Results in increased heat in hydraulic drive system.

SEED LUBRICANT RATES		
SEED (BU.)	GRAPHITE ONLY (CUPS)	50/50 GRAPHITE/TALC BLEND (CUPS)
2	1/8	1/8
5	1/4	1/4
6	3/8	3/8
8	1/2	1/2
10	3/4	3/4
15	1	1
20	1-1/4	1-1/4
25	1-1/2	1-1/2
30	2	2
40	2-1/2	2-1/2
50	3-1/8	3-1/8
60	3-3/4	3-3/4

Note: 1 lb. of graphite or graphite/talc mixture = approx. 3 cups



ADJUSTMENTS

POPULATION ADJUSTMENTS

- If equipped with an AFS Pro 600/700 display and hydraulic drive, all population adjustments are made through the display. Check the seed disk selection chart to be sure the proper disk is installed.
- If equipped with a mechanical seed meter drive, check the operator's manual for the proper sprocket configuration for the desired population. Also reference the seed disk selection chart to be sure the proper seed disk is installed.

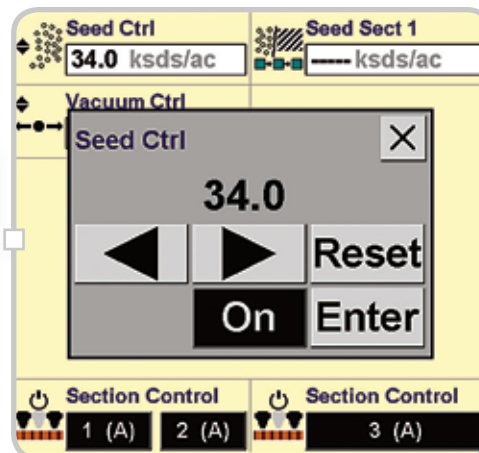

As stated earlier, the key to accurate seed meter adjustment is to take the time to open the trench and check seed placement and spacing, counting the seed population over a specified row length.

- The table indicates the row length required to be opened to equal 1/1000th of an acre.
- Counting the seed in this distance and multiplying by 1000 will give an accurate indication of seed population.
- Adjust the singulator dial to a higher number setting per the recommended settings chart on the next page (Corn is "3", Soybeans is "8", etc). Adjustments to a lower number can be made if doubles are being observed (i.e. population is high, or to a higher number if skips are being seen (population is low). **NOTE: Do not attempt to use a singulator to control population, only to eliminate "doubles".**
- Move the adjustment handle (A), to adjust the baffle (B) to control the depth of seed in the meter housing that is exposed to the seed disk.

ROW WIDTH (INCHES)	ROW LENGTH = 1,1000th OF AN ACRE
12	34.8
20	26.2
22	23.8
30	17.4
36	14.5
38	13.8
40	13.1

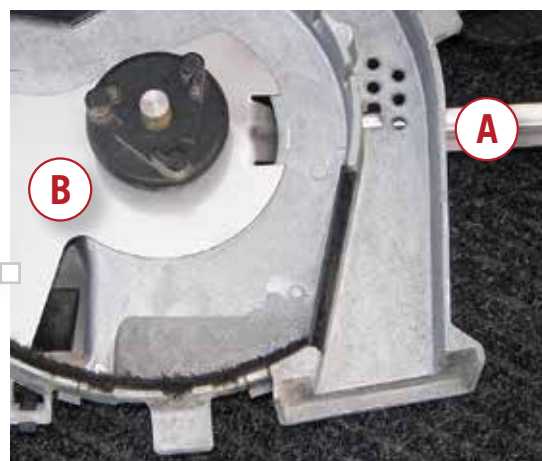

ADJUSTMENTS

ADVANCED SEED METER RECOMMENDED SETTINGS

Seed Singular Settings:

The Advanced Seed Meter will accurately plant most seeds. The chart is a guideline to help optimize performance. It provides the range setting for seed sizes best suited for respective discs.

IMPORTANT: If your seed meters are equipped with the older style singulator that uses a lever instead of a dial for adjustment, divide the singulator setting value from this chart in half.

Advanced Seed Meter Recommended Settings (e)

TABLE NOTES:

- Seed disk designation indicates number of holes and hole diameter; i.e. seed disk 4855 contains 48 holes with each hole diameter of 5.5 mm.
- Vacuum level is set by controlling fan speed control with seed on disc. Setting is in inches of water (inch H₂O).
- Meter cover indicates baffle position number. Meter inspection without draining seed can be made when baffle is set to position 0 (fully closed).
- Do not use Singulator dial (lever) settings to control gross population; excessive doubles or skips will occur. Higher dial setting decreases singulator interference with seed disk holes.
- Use the Seed Population/Spacing Chart and Seed Disk RPM Chart in this Section to determine disk RPM.

Crop	Seeds/lb	Seed Disc Ordering Number	(a) Seed Disc Number	(b) Vacuum Setting In (H ₂ O)	(c) Baffle Setting	(d) Singulator Dial Setting	Bulk Fill Settings If Equipped		
							Bulk Fan RPM Speed	1245 (1255) (1265)	5 Series Inductor Air Baffle
Corn									
	1700-2400	192995A1	4855	18-20	2	3			
	1700-2400	275116A1	2455	18-20	2	3	1240/50 - 3500		Large Seed Baffle
	1700-2400	84217654	3655	18-20	2	3	1245 - 3600		
	1200-1700	192995A1	4855	20-22	2	3	1255 - 3500		
	1200-1700	275116A1	2455	20-22	2	3	1260/65 - 3000		
	1200-1700	84217654	3655	20-22	2	3			
Select Seed Disc based on optimum Disc RPM for the seed spacing and planting seed speed used. See Seed Disc RPM chart.									
Sweet Corn									
	3850-4600	326781A1	4835	22-24	3	3	1245 - 3700		Large Seed Baffle
	2400-3100	192993A1	4845	20-22	3	3	1255 - 3700		
	2100-2400	192995A1	4855	16-18	3	2	1265 - 3000		
Popcorn									
	3500-4600	328083A1	4830	26-30	2	4	1240/45/50 - 3500		Small Seed Baffle
	2500-3500	326241A1	4840	18-20	2	3	1255 - 3700		
	1500-2500	192995A1	4855	18-20	2	3	1260/65 - 3000		
Soybean									
	3500-4500	397839A1	13035-SB	15-17	2	8	1240/50 - 3500		Large Seed Baffle
	3500-4500	87698876	10035-SB	15-17	2	8	1245 - 3600		
	3500-4500	87420630	8035-SB	15-17	2	8	1255 - 3300		
	2600-3500	193017A1	13045	15-17	2	8	1260 - 3400		
	2000-3500	87698875	10045-SB	15-17	2	8	1265 - 3000		
	2000-3500	377669A1	8045-SB	15-17	2	8			
Select Seed Disc based on optimum Disc RPM for the seed spacing and planting seed speed used. See Seed Disc RPM chart. 13035-SB and 13045 seed Discs have 2 staggered rows of holes. Select 100 hole Disc if seed crowds together on the 130 hole Disc.									
Sorghum/Milo									
	12,000-19,000	326239A1	2423	22-25	1	4	1240/50 - 3000		Small Seed Baffle
	12,000-19,000	232711A2	8023	22-25	1	4	1245 - 3200		
	12,000-19,000	232712A2	12023	22-25	1	4	1255 - 3300		
Select seed Disc based on optimum Disc RPM for the seed spacing and planting seed speed used. See Seed Disc RPM chart.									
Edible Bean									
	2300-3000	192997A1	8045	20-22	2	5			Not Recommended for Bulk Fill Planters
	1000-2300	232706A1	6055	24-26	2	5			
	1400-1800	447861A1	8045-C	24-26	2	7			
	800-1000	193002A1	6060	20-22	3	6			
Sunflower									
	7000-10,500	326239A1	2423	20-22	1	3	1245 - 2800		Small Seed Baffle
	4000-7000	326240A1	2440	20-22	2	3	1255 - 3200		
	2000-4000	275116A1	2455	20-22	2	3	1265 - 2700		
Cotton									
	5000-6300	447947A1	8035-DC	16-18	2	4			Large Seed Baffle
	4200-5000	447947A1	8035-DC	20-22	2	4	1245 - 3500		
	4200-6300	47512717	6030	16-22	2	4	1255 - 3000		
	4200-6300	84222452	40x2/8030	16-18	2	10	1265 - 2700		
	4200-6300	365249A1	20x3/6030	14-16	2	10			
	4200-6300	84222453	20x4/8030	16-18	2	10			
Hill Drop Cotton seed Disc is designed to plant three seeds per hill. For optimum performance, reduce ground speed.									
Encrusted Sugar Beet									
	22,000-38,000	84183356	60175	16 - 20	1	4	1240/55 - 2000		Small Seed Baffle
		236027A*	80175	16 - 20	1	4	1245 - 3200		
		84183357	6020	18 - 20	1	4	1255 - 3200		
	13,000-22,000	84183358	6023	18 - 20	1	4	1260 - 2000 (sm seed)		
		326242A*	8020	18 - 20	1	4	1260 - 2200 (lr seed)		
		232711A*	8023	18 - 20	1	4	1265 - 2500		
60 cell Discs are generally recommended to maintain proper Discs speeds. Refer to Seed Disc RPM chart for your application.									
Pelleted Sugar Beet									
	>20,000	84183357	6020	16 - 20	1	4	1240/55 - 2000		Small Seed Baffle
		326242A*	8020	16 - 20	1	4	1245 - 3200		
	12,000 - 20,000	84183357	6020	18 - 22	1	4	1255 - 3200		
		326242A*	8020	18 - 22	1	4	1260 - 2000 (sm seed)		
	8,000 - 12,000	84183358	6023	20 - 24	1	4	1260 - 2200 (lr seed)		
		232711A*	8023	20 - 24	1	4	1265 - 2500		
60 cell Discs are generally recommended to maintain proper Discs speeds. Refer to Seed Disc RPM chart for your application.									
Peanut									
	1000-1400	193002A1	6060	20-22	2	6			Not Recommended for Bulk Fill Planters
	1000-1400	232706A1	6055	24-26	2	6			
	800-1000	327103A1	4880	20-22	2	6			
	800-1000	193002A1	6060	20-22	3	6			
	600-800	353801A1	6065	22-24	3	6			
	600-800	193003A1	4865	22-24	3	6			
** Additional care is needed for peanut seeds larger than 800 seeds/pound. For optimum planter performance, reduce ground speed. Adjustment for drive wheel slip and selecting/maintaining the proper vacuum setting are critical for planting the desired population. Always verify planter performance by digging seeds.									
† For peanuts smaller than 800 seeds per pound, see the following pages for suggested planting speeds.									
Select 48 hole Disc if seed crowds together on the 60 hole Disc. Brushes can be removed.									
Remove the straight brush from the holder for Virginia peanuts.									

1200 SERIES EARLY RISER® PLANTER

ADJUSTMENTS

ADVANCED SEED METER RECOMMENDED SETTINGS (CONTINUED)

SEED METER, VACUUM AND BULK SETTINGS

Seed Population/Spacing Chart

Use this table to determine expected seed spacing or different populations and row widths.

Determining Seed Disk RPM

Use the table on the following page to approximate seed disk RPM for you planting speed, seed spacing and seed disk.

For all Case IH 1200 Series hydraulic drive planters, seed disk RPM must be greater than 12 RPM for reliable results.

For all Case IH 1200 Series planters - ground and hydraulic drive, seed disk RPM should NEVER exceed 60 RPM. Damage to meter components will occur.

Shaded areas in the chart indicate optimal RPM range. Values in italic indicate RPMs slower than 12 RPM.

Seed Disk RPM Formula

Use the following formula to calculate Seed Disk RPM for your specific planting parameters:

$$\frac{1}{\text{Disk Holes}} \times \frac{1}{\text{Spacing}} \times \text{Speed (mph)} \times 1056 = \text{Disk RPM}$$

Disk Holes = No. of holes in the seed disk

Spacing = Seed spacing in inches

Speed = Planting speed in mph

1056 = Constant Value

Example:

Holes in Disc = 48

Inch Seed Spacing = 4.25 in.

MPH Planting Speed = 5.0

Divide 1 by 48 (no. disk holes) = 0.021

Divide 1 by 4.25 (seed spacing) = 0.235

Multiply 0.021 x 0.235 x 5 (mph) x 1056 = 26 RPM

Using a 48 hole seed disk and seed spacing of 4.25 inch, when traveling at 5 mph, the seed disk will rotate at 26 RPM, well within the required range of 12-60 RPM.

Seed Spacing (Inch per seed)	Seed Population							
	Seed/Acre 15 Inch Rows	Seed/Acre 20 Inch Rows	Seeds/Acre 22 Inch Rows	Seed/Acre 30 Inch Rows	Seed/Acre 36 Inch Rows	Seed/Acre 38 Inch Rows	Seed/Acre 40 Inch Rows	
0.25	1,672,704	1,254,528	1,140,480	836,352	696,960	660,278	627,264	
0.50	836,352	627,264	570,240	418,176	348,480	330,139	313,632	
0.75	557,568	418,176	380,160	278,784	232,320	220,093	209,088	
1.00	418,176	313,632	285,120	209,088	174,240	165,069	156,816	
1.25	334,541	250,906	228,096	167,270	139,392	132,056	125,453	
1.50	278,784	209,088	190,080	139,392	116,160	110,046	104,544	
1.75	238,958	179,218	162,926	119,479	99,566	94,325	89,609	
2.00	209,088	156,816	142,560	104,544	87,120	82,535	78,408	
2.25	185,856	139,392	126,720	92,928	77,440	73,364	69,696	
2.50	167,270	125,452	114,048	83,635	69,696	66,028	62,726	
2.75	152,064	114,048	103,680	76,032	63,360	60,025	57,024	
3.00	139,392	104,544	95,040	69,696	58,080	55,023	52,272	
3.25	128,670	96,502	87,729	64,335	53,612	50,791	48,251	
3.50	119,479	89,610	81,463	59,739	49,783	47,163	44,805	
3.75	111,514	83,636	76,032	55,757	46,464	44,019	41,818	
4.00	104,544	78,408	71,280	52,272	43,560	41,267	39,204	
4.25	98,394	73,796	67,087	49,197	40,998	38,840	36,898	
4.50	92,928	69,696	63,360	46,464	38,720	36,682	34,848	
4.75	88,037	66,028	60,025	44,019	36,682	34,751	33,014	
5.00	83,635	62,726	57,024	41,818	34,848	33,014	31,363	
5.25	79,653	59,740	54,309	39,826	33,189	31,442	29,870	
5.50	76,032	57,024	51,840	38,016	31,680	30,013	28,512	
5.75	72,726	54,544	49,586	36,363	30,303	28,708	27,272	
6.00	69,696	52,272	47,520	34,848	29,040	27,512	26,136	
6.25	66,908	50,182	45,619	33,454	27,878	26,411	25,091	
6.50	64,335	48,252	43,865	32,167	26,806	25,395	24,126	
6.75	61,952	46,464	42,240	30,976	25,813	24,455	23,232	
7.00	59,739	44,804	40,731	29,870	24,891	23,581	22,402	
7.25	57,679	43,260	39,327	28,840	24,033	22,768	21,630	
7.50	55,757	41,818	38,016	27,878	23,232	22,009	20,909	
7.75	53,958	40,468	36,790	26,979	22,483	21,299	20,234	
8.00	52,272	39,204	35,640	26,136	21,780	20,634	19,602	
8.25	50,688	38,016	34,560	25,344	21,120	20,008	19,008	
8.50	49,197	36,898	33,544	24,599	20,499	19,420	18,449	
8.75	47,792	35,844	32,585	23,896	19,913	18,865	17,922	
9.00	46,464	34,848	31,680	23,232	19,360	18,341	17,424	
9.25	45,208	33,906	30,824	22,604	18,837	17,845	16,953	
9.50	44,019	33,014	30,013	22,009	18,341	17,376	16,507	
9.75	42,890	32,168	29,243	21,445	17,871	16,930	16,084	
10.00	41,818	31,364	28,512	20,909	17,424	16,507	15,682	
10.25	40,798	30,598	27,817	20,399	16,999	16,104	15,299	
10.50	39,826	29,870	27,154	19,913	16,594	15,721	14,935	
10.75	38,900	29,176	26,523	19,450	16,208	15,355	14,588	
11.00	38,016	28,512	25,920	19,008	15,840	15,006	14,256	
11.25	37,171	27,878	25,344	18,586	15,488	14,673	13,939	
11.50	36,363	27,272	24,793	18,182	15,151	14,354	13,636	
11.75	35,589	26,692	24,266	17,795	14,829	14,048	13,346	
12.00	34,848	26,136	23,760	17,424	14,520	13,756	13,068	
12.25	34,137	25,602	23,275	17,068	14,224	13,475	12,801	
12.50	33,454	25,090	22,810	16,727	13,939	13,206	12,545	
12.75	32,798	24,598	22,362	16,399	13,666	12,947	12,299	
13.00	32,167	24,126	21,932	16,084	13,403	12,698	12,063	
13.25	31,560	23,670	21,518	15,780	13,150	12,458	11,835	
13.50	30,976	23,232	21,120	15,488	12,907	12,227	11,616	
13.75	30,413	22,810	20,736	15,206	12,672	12,005	11,405	
14.00	29,870	22,402	20,366	14,935	12,446	11,791	11,201	
14.25	29,346	22,010	20,008	14,673	12,227	11,584	11,005	
14.50	28,840	21,630	19,663	14,420	12,017	11,384	10,815	
14.75	28,351	21,264	19,330	14,175	11,813	11,191	10,632	
15.00	27,878	20,908	19,008	13,939	11,616	11,005	10,454	

ADJUSTMENTS

ADVANCED SEED METER RECOMMENDED SETTINGS (CONTINUED)

Seed Spacing (inch per seed)	Seed Disk RPM																							
	24 Cell Disk			36 Cell Disk			48 Cell Disk			60 Cell Disk			80 Cell Disk			100 Cell Disk			120 Cell Disk			130 Cell Disk		
	4 MPH	6 MPH	8 MPH	4 MPH	6 MPH	8 MPH	4 MPH	6 MPH	8 MPH	4 MPH	6 MPH	8 MPH	4 MPH	6 MPH	8 MPH	4 MPH	6 MPH	8 MPH	4 MPH	6 MPH	8 MPH	4 MPH	6 MPH	8 MPH
0.25	Meter Recommendations																							
0.50	Optimal Meter RPM: shaded region																							
0.75	Do not operate Meter greater than 60 RPM																							
1.00	Hydraulic Drive not recommended below 12 RPM																							
1.25																								
1.50								59					56											
1.75								50					47											
2.00								44					40											
2.25								39	59				35	53										
2.50								47					31	47										
2.75								35	53				28	42	56									
3.00								32	48				26	38	51	19	29	38	15	23	31	13	19	26
3.25								29	44	59			23	35	47	18	26	35	14	21	28	12	18	23
3.50								27	41	54			22	32	43	16	24	32	13	19	26	11	16	22
3.75								25	38	50			20	30	40	15	23	30	12	18	24	10	15	20
4.00								23	35	47			19	28	38	14	21	28	11	17	23	9	14	19
4.25								21	31	41			17	25	33	12	19	25	10	15	20	8	12	17
4.50								26	39	52			16	23	31	12	18	23	9	14	19	8	12	16
4.75								25	37	49			15	22	30	11	17	22	9	13	18	7	11	15
5.00								23	35	47			14	21	28	11	16	21	8	13	17	7	11	14
5.25								18	26	35			13	20	27	10	15	20	8	12	16	7	10	13
5.50								17	25	34			13	19	26	10	14	19	8	12	15	6	10	13
5.75								16	24	32			13	19	26	10	14	19	8	12	15	6	9	12
6.00								15	22	29			12	18	24	9	14	18	7	11	15	6	9	12
6.25								15	22	29			12	18	23	9	13	18	7	11	14	6	9	12
6.50								14	21	28			11	17	23	8	13	17	7	10	14	6	8	11
6.75								14	20	27			11	16	22	8	12	16	6	10	13	5	8	11
7.00								13	20	26			10	16	21	8	12	16	6	9	13	5	8	10
7.25								13	19	25			10	15	20	8	11	15	6	9	12	5	8	10
7.50								12	18	24			10	15	19	7	11	15	6	9	12	5	7	10
7.75								12	18	23			9	14	19	7	11	14	6	8	11	5	7	9
8.00								11	17	23			9	14	18	7	10	13	5	8	11	5	7	9
8.25								11	16	21			9	13	17	6	10	13	5	8	10	4	6	8
8.50								10	16	21			8	12	17	6	9	12	5	7	10	4	6	8
8.75								10	15	20			8	12	16	6	9	12	5	7	10	4	6	8
9.00								10	15	20			8	12	16	6	9	12	5	7	9	4	6	8
9.25								10	14	19			8	11	15	6	9	11	5	7	9	4	6	8
9.50								9	14	19			7	11	15	6	8	11	4	7	9	4	6	8
9.75								9	14	18			7	11	14	5	8	11	4	6	9	4	5	7
10.00								9	13	18			7	11	14	5	8	11	4	6	8	4	5	7
10.25								9	13	17			7	10	14	5	8	10	4	6	8	3	5	7
10.50								8	13	17			7	10	13	5	8	10	4	6	8	3	5	7
10.75								8	12	16			7	10	13	5	7	10	4	6	8	3	5	7
11.00								8	12	16			6	10	13	5	7	10	4	6	8	3	5	7
11.25								8	12	16			6	9	13	5	7	9	4	6	8	3	5	6
11.50								8	11	15			6	9	12	5	7	9	4	6	7	3	5	6
11.75								7	11	15			6	9	12	4	7	9	4	5	7	3	4	6
12.00								7	11	15			6	9	12	4	7	9	4	5	7	3	4	6
12.25								7	11	14			6	9	11	4	6	9	3	5	7	3	4	5
12.50								7	11	14			6	8	11	4	6	8	3	5	7	3	4	5
12.75								7	10	14			6	8	11	4	6	8	3	5	7	3	4	5
13.00								7	10	14			5	8	11	4	6	8	3	5	6	3	4	5
13.25								7	10	13			5	8	11	4	6	8	3	5	6	3	4	5
13.50								7	10	13			5	8	10	4	6	8	3	5	6	3	4	5
13.75								6	10	13			5	8	10	4	6	8	3	5	6	3	4	5
14.00								6	9	13			5	8	10	4	6	8	3	5	6	3	4	5
14.25								6	9	12			5	7	10	4	6	7	3	4	6	2	4	5
14.50								6	9	12			5	7	10	4	5	7	3	4	6	2	4	5
14.75								6	9	12			5	7	10	4	5	7	3	4	6	2	4	5
15.00								6	9	12			5	7	9	4	5	7	3	4	6	2	4	5

CUSTOM SEED DISKS

Some seeds may have size or shape characteristics that present seed metering challenges. Case IH offers customers the opportunity to purchase custom seed disks for these special circumstances. Custom disks may help operators optimize their Case IH planter for even the most unusual seed metering conditions. A special seed disk order form entitled Seed Disk Order Form (XL), is available to your Case IH dealer for acquiring custom seed disks. There are conditions on the purchase of custom seed disks, which your Case IH dealer will be able to explain prior to purchase.

ADJUSTMENTS

EARLY RISER ROW UNIT ADJUSTMENTS

MECHANICAL SPRING ADJUSTMENT

Row unit down pressure can be adjusted to increase or decrease force pushing the opener disks into the soil, as required by soil conditions.

- Down pressure is changed without tools by adjusting the location of the pressure spring pin into either of three slots.
- The planter must be raised partially to relieve pressure on the down pressure system to make adjustments.
- Adverse planting conditions such as hard or rough soil may require high down pressure. (Front hole) Down pressure should be set only as great as necessary to prevent accelerated wear on the row unit ground-engaging components.
- In rough conditions, adjust to the lowest possible pressure (Rear Slot) to prevent damage and breakage due to contact with stones and rocks.
- Reduce down pressure in soft or sandy conditions to allow the opener to slice through the soil without pushing or “bulldozing” soil.



If row units bounce excessively in adverse conditions, even with high down pressure settings:

- Reduce ground speed
- Improve seedbed preparation with additional tillage

SPRING DOWN PRESSURE SETTINGS:

- Long Slot = 105 lbs.
- Medium Slot = 142 lbs.
- Short Slot = 180 lbs.



ADJUSTMENTS

DON'T HAVE PNEUMATIC DOWN PRESSURE ON YOUR 1200 PLANTER? KITS ARE AVAILABLE TO INSTALL IT!

Pneumatic Down Pressure (PDP) Kits for 1200

Series Planters Feature:

- Basic component kits make ordering easy
- Infinite down pressure adjustment from 0-260 lb
- Pressure maintained constant at all times while planting for consistent depth control
- Single point adjustment at compressor, with air gauge to monitor pressure
- Individual air spring on each row unit
- Kits available to adjust pneumatic down pressure from the AFS Pro 600 or AFS Pro 700 display. See your Case IH salesman for more details!



BASIC COMPONENT KIT CONTENTS		
ROW UNIT KITS	AIR PUMP ASSEMBLY	TUBE & FITTING KIT
Upper links	Pump assembly	100 ft. - 1.4 in. bulk tubing
Pivot bushings	Pressure gauge	Tees
Pneumatic springs	Tank Valve	Plugs
Brackets	Brackets	Tie straps
Hardware	Decal	

BASIC COMPONENT KIT PART NUMBERS	
PART NUMBER	DESCRIPTION
84161578	14 in. Row unit linkage kit
84161583	24 in. Row unit linkage kit
84161584	Tubing & fitting kit
84161586	Air pump kit

PNEUMATIC DOWN PRESSURE ADJUSTMENT (OPTIONAL)

Pneumatic down pressure is adjusted by placing the row units in the planting position, and activating the air pump toggle while monitoring pressure on the pump-mounted gauge. Refer to the decal for approximate down pressure corresponding to air pressure setting.

IMPORTANT

- Set Pressure to add Down-Force to Row Units

PSI	Added Down-Force (lbs)
20	50
40	100
60	155
80	210
100	260

IN-CAB PNEUMATIC DOWN PRESSURE (1230/35, 1240/45, 1250/55, & 1260/65 ONLY)

If in-cab pneumatic down pressure is installed, down pressure can be adjusted directly from the AFS Pro 600 or AFS Pro 700 display.

Simply place the 'Down Force Ctrl' window on a run screen and make adjustments as needed!

The 'Down Force' window can be placed on the run screen to monitor what the actual down force is.

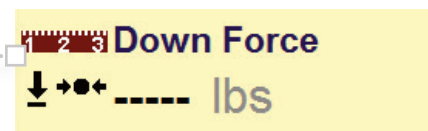

ADJUSTMENTS

PNEUMATIC DOWN PRESSURE ASSIST SPRING

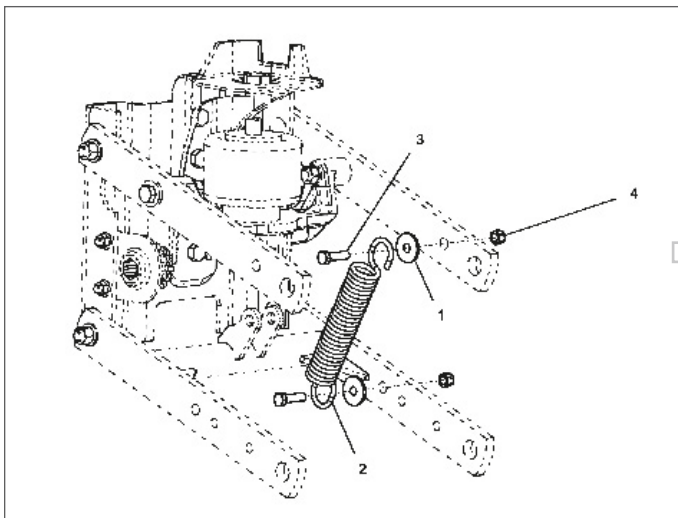

In those extreme conditions (double crop soybeans for example) additional down force, beyond what the pneumatic down force system can provide, is needed. An assist spring kit is available to add approximately 50 lbs. of additional down force.

P/N - 84158977 (1 row unit)

PLANTING DEPTH ADJUSTMENTS



- Planting depth is adjusted according to soil moisture conditions and is changed by turning the control handle on the rear of each row unit.

- Raise the planter to remove pressure from the gauge wheels when making depth adjustments.
- Adjust all rows evenly, and place the adjustment handle in the lock after setting the adjustment.
- Check the actual planting depth by digging to the bottom of the seed trench after making adjustments.

CLOSING SYSTEM ADJUSTMENTS

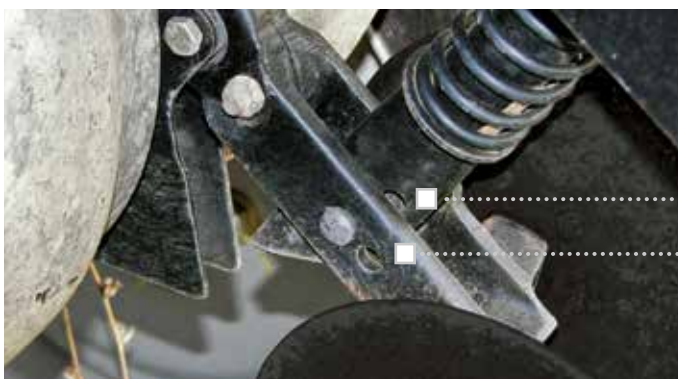

Covering disks can be adjusted for both operating depth and closing disk down pressure spring affect.

- Holes in the down pressure spring assembly adjust the covering disk depth.
- Holes in the covering disk arm affects the leverage on the disk arm exerted by the down pressure spring.

Tip: If additional closing disk down pressure is needed, install the Heavy Duty Down Pressure spring kit. **P/N - 84606219**

PLANTER OPTIONS

CASE IH OFFERS CUSTOMERS NUMEROUS OPTIONS TO CUSTOMIZE YOUR PLANTER TO YOUR SPECIFIC AGRONOMIC NEEDS.



LIQUID FERTILIZER

Promote faster, earlier seed growth by applying liquid starter fertilizer during planting.

- Large-capacity polyethylene tanks hold 70 to 600 gallons.
- Can be mounted on the toolbar or your tractor, depending on the planter configuration.
- Planter mounted liquid fertilizer is available on 6- and 8-row trailing as well as 12- and 16-row Pivot-Transport. Also available on 12-, 16-, 24-, 32 and 36-row Front-Fold planters.
- High-output Case IH diaphragm pump on Pivot-Transport and Front-Fold planters for greater reliability and lower maintenance.

FOUR DIFFERENT TYPES OF OPENERS:

1. Double-disk opener works well in conventional- and Mulch-till fields
2. Single-disk No-till opener with fertilizer knife with 17 in. rippled coulter and parallel linkage for Mulch-till and No-till operations
3. Single-disk opener with liquid injection (pivot planters only)
4. Single disk opener for 1250 Front-Fold planters



DRY FERTILIZER (1220 PLANTERS ONLY)

Boost the potential of every plant with dry fertilizer application.

- Dry fertilizer hoppers hold from 600 to 900 lbs. each, depending on the planter configuration
- Planter mounted dry fertilizer is available on 6- and 8-row trailing configurations only
- 45 different application rates and low-, high- or extra high-rate augers

PLANTER OPTIONS

DRY FERTILIZER (CONTINUED)

Two opener styles:

1. Double-disk opener is perfect for conventional- and Mulch-till conditions.
2. Single-disk opener with 17 in. rippled coulter for No-Till for no-till fields.
 - A knife scraper can be added to keep openers clean
 - Optional gauge wheels allow for placement 3 or 4 inches deep



GRANULAR CHEMICAL APPLICATION

Control weeds and pests right from the start by applying granular treatments.

- Granular chemical hoppers hold 70 lbs. of either herbicide or insecticide, or 35 lbs. of each when used with a conversion divider.

For insecticide application, a front or rear insecticide spreader puts chemical in a narrow band either before the opener or after the press wheel.

- In-furrow hose places insecticide in the seed trench.
- Surface-apply, apply in-furrow or T-band insecticide.
- Add a closed handling lid-fill system that reduces operator exposure.
- For herbicide application, a rear-mounted herbicide spreader handles distribution over the closed furrow. Add a herbicide windshield when banding on windy days.
- Spring-tooth incorporator to help mix soil and chemicals, leveling and loosening soil to lessen crusting or erosion.



AFS ACCU-ROW CONTROL

Get GPS-based row unit shutoff capabilities with the AFS Accu-Row Control option. It automatically disengages rows when you are overlapping areas of the field that have already been planted.

- Group 1, 2, 3 or 4 rows together, depending on configuration.
- Controlled via the AFS Pro 600 or AFS Pro 700 display

See your Case IH Dealer for more details on how to take advantage of this seed saving/yield improving option!



PLANTER OPTIONS

ROW UNIT ATTACHMENTS (CONTINUED)



9.25 in. Smooth,
12 in. Smooth,
or 12-in. Notched Disk Furrower



Standard Tine Wheel Residue Manager,
Dual Wheel and/or Floating No-Till
Residue Manager, Dual Wheel.



Floating Combo Tine Wheel
Residue Manager with
25 Wave Coulters, Dual Wheel.



Row Unit Mounted Coulters
8 Wave or 25 Wave.



Rotary Scraper
P/N – 1547680C1



No-Till Residue Manager, Dual Wheel
and/or Floating No-Till Residue
Manager, Dual Wheel.



"V" Furrowing Wing



Notched Marker Disk
P/N – 432620A1
Marker Depth Band (not shown)
P/N – 87557028



Heavy-duty Closing Disk
Downpressure Spring Kit
P/N – 84606219

1200 SERIES EARLY RISER® PLANTER

DISPLAYS

MONITORS AND DISPLAYS

Several displays are available to control or monitor the Early Riser planters. To understand the functionality of each, see the chart below.

MONITOR SYSTEM COMPARISON				
Feature	AFS Pro 600	AFS Pro 700	Early Riser III	Early Riser IV
Early Riser Planter Models	All	All	1210, 1220, 1230	1215, 1225, 1235, & 1250/55 (12R & 16R only)
Rate Sensitive Alarm	•	•	•	•
High / Low Population Warning	•	•	•	•
Seed Population	•	•	•	•
Seed Spacing	•	•	•	•
Row Failure	•	•	•	•
Average Population	•	•	•	•
Seed Counter (row)	•	•	—	•
Seed Rate Bar Graph	•	•	•	•
Acre counter (field)	•	•	•	•
Total Acreage (season)	•	•	•	•
Lifetime Area	•	•	—	—
Ground Speed	•	•	•	•
Area / Hr	•	•	•	•
Vacuum Rate	•	•	—	—
Vacuum Control	•	•	—	—
Bulk Fill Fan Rate	•	•	NA	•
Bulk Fill Fan Control	•	•	NA	—
Bin Level Indicator	•	•	—	—
Metric / US unit support	•	•	•	•
Steerable Axle Control (1260/1265 only)	•	•	NA	—
Bin Level Alarm	•	•	—	•
Liquid Fertilizer Control - Single Channel (1240/45, 1250/55, and 1260/65 only)	•	•	—	—
In-Cab Pneumatic Down Pressure control	•	•	—	—
Maximum number of rows	20 rows per section	20 rows per section	16	16
Maximum number of seed drive sections	4	4	1	2 (Frame Box Control)
GPS control of seed drive shut off (Overlap & Boundary Control)	•	•	—	—
GPS control of individual row shut off (AccuRow Control)	•	•	—	—
Fold and Row Marker control	Display Control	Display Control	Frame Box Control	Frame Box Control
Early Riser 1210/1215	•	•	w/ Marker Package	•
Early Riser 1220/1225	•	•	w/ Marker Package	•
Early Riser 1230/1235	•	•	•	•
Early Riser 1240/1245	•	•	NA	—
Early Riser 1250/1255	•	•	NA	•
Early Riser 1260/1265	•	•	NA	—
Rate Recording Capable (As-Applied)	•	•	—	—
Map Based Prescription Control – Seed (Variable Drive Option only) and Fertilizer				
Early Riser 1210/1215	NA	NA	—	—
Early Riser 1220/1225	•	•	—	—
Early Riser 1230/1235	•	•	—	—
Early Riser 1240/1245	•	•	NA	—
Early Riser 1250/1255	•	•	NA	—
Early Riser 1260/1265	•	•	NA	—
AccuStat - Singulation, Skips, Doubles, Spacing, CV reporting & recording (12*5 series planters only)	—	•	—	—
Record Position of Field Marks	•	•	—	—
Video camera inputs (total of three cameras)	—	•	—	—
Compatible with Case IH Tractor, Combine, SP Sprayer and other AFS Systems	•	•	—	—

NA = Not applicable

DISPLAYS



1200 SERIES EARLY RISER® PLANTER

DISPLAYS

EARLY RISER® IV DISPLAY

The Case IH Early Riser IV monitor offers an economical and easy way to monitor the ground drive Early Riser planter. This display is simple to navigate and provides basic population monitoring, field area, ground speed, hopper level alarms and bulk fill fan speed reporting (1250/55 only).

Navigation

The diagram shows the control panel of the Early Riser IV monitor. It features a central display screen, a directional keypad with eight arrow keys, and a numeric keypad with eight function keys. The function keys are arranged in two rows: the top row contains 'PLANTER CONFIG SETUP', 'DIST CAL', 'SEED POP ALARM', and 'TOOL BOX'; the bottom row contains 'RUN', 'SUB SYSTEM SETUP', 'SEED COUNT', and 'SPEED AREA MODE'. The monitor is labeled 'EARLY RISER IV' and 'CASE IH'.

UP/DOWN ARROW KEYS
When modifying a numerical value, use the Up and Down arrow keys to increase or decrease the value a single digit at a time.

LEFT/RIGHT ARROW KEYS
On setup screens, use the Left and Right arrow keys to navigate horizontally through a layout.

POWER KEY
The Power key powers up or powers down the monitor.

ESCAPE KEY
On the Operate (main) screen, press and hold the Escape key for four seconds to clear an area accumulator if it is located on the top line of the display area. After modifying the value for a field, press the Escape key to confirm the selection.

ENTER KEY
Use the Enter key to select a field for modifying. After modifying the field value, press the Enter key to confirm the selection.

ALARM CANCEL KEY
During normal operation, press the Alarm Cancel key to acknowledge the alarm condition displayed on the screen.
Alarm volume level: When no alarm conditions are active, use the Alarm Cancel key to select the volume level for the alarm. Press and hold the Alarm Cancel key to cycle through the three volume levels. Release the key to select your preferred volume level. The default is the loudest volume level.

PLANTER CONFIGURATION SETUP KEY
The **PLANTER CONFIG SETUP** key displays the planter setup screen. Use this screen to select the number of rows, row spacing, implement width and row type.

DISTANCE CALIBRATION KEY
The **DIST CAL** key displays the ground speed screen. Use this screen to perform ground speed calibration, to set manual ground speed when no ground speed—radar or sensor—is present, or to set the maximum ground speed alarm.

SEED POPULATION ALARM KEY
The **SEED POP ALARM** key displays the population limits screen. Use this screen to set the target population value, the upper and lower limit values, a population adjustment factor and the population alarm response time.

TOOLBOX KEY
The **TOOLBOX** key displays the display and service setup screen. Use this screen to select the layout and content for the upper and lower display areas on the Operate screen. The service icon on this screen displays software and hardware versions, as well as total unit and acres for the monitor.

RUN KEY
The **RUN** key displays the main screen used when planting. Use this screen to monitor planting operations. When the Run key is used to exit a setup screen, any changes made on the setup screen are saved when Run is pressed.

SUB SYSTEM SETUP KEY
Functional on the 1255/1250 Front Fold Trailing planter ONLY
The **SUB SYSTEM SETUP** key is used to navigate to the Sub-System Setup screen for selection of a fan (RPM) / shaft (RPM) / or flow (G/MIN or L/MIN) labels, upper and lower alarm limits and calibration (or manual calibration number entry).

SEED COUNT KEY
The **SEED COUNT** key is used to navigate to the Seed Count screen. This mode allows the operator to test the planter for proper operation prior to field use.

SPEED AREA MODE KEY
The **SPEED AREA MODE** key is used to navigate to the Speed Area Distance screen. This mode allows use of the console for non-planting operations. This mode is also used to start, stop, or clear the three independent area accumulators (FIELD AREA 1, FIELD AREA 2, and TOTAL AREA).

DISPLAYS

EARLY RISER® IV DISPLAY (CONTINUED)

Distance Calibration

For accurate ground speed, population reporting and acre counting.



To perform Distance calibration, press the DIST CAL key.

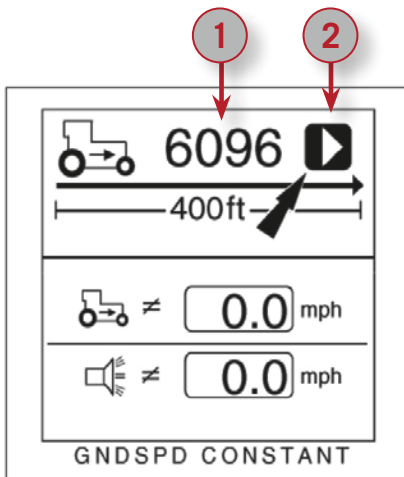

1. The setup screen displays with the ground speed constant Value (1) highlighted.

Measure a **122 m (400 ft.)** course, and place a marker at the beginning and end of the measured course.

NOTE: A measuring tape is preferred over a measuring wheel to determine the course length since it provides greater accuracy.

2. Use the **right ARROW key** to highlight the **START** soft key (2). Drive at a constant speed to the start of the course at **3-8 km/h (2-5 mph)**. When the tractor is even with the beginning marker, press **ENTER** to start the calibration.

A **STOP** soft key appears.

NOTE: Careful alignment with the start position is critical for the most accurate measurement.

3. Drive to the end of the measured course at **3-8 km/h (2-5 mph)**. When the tractor is even with the end marker, press **ENTER** to stop the calibration.

4. The new calibration value displays. Record this value. Repeat this procedure two more times and calculate the average: add the calibration value from each run together and divide by the number of runs.

$$\frac{\text{Run 1} + \text{Run 2} + \text{Run 3}}{\# \text{ of Runs}} = \text{Cal Average}$$

5. Enter the average calibration value from the three runs.

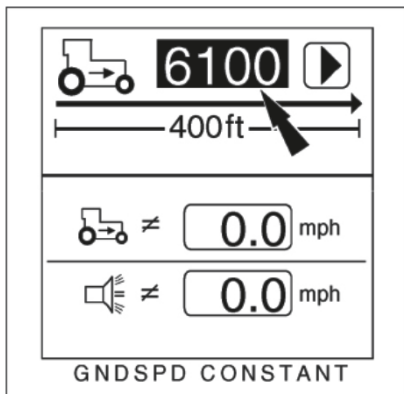

DISPLAYS

EARLY RISER® IV DISPLAY (CONTINUED)

Target Population/Row Alarm Setup



Press the **SEED POP ALARM** key to setup Target, Max/Min Alarm, Adjustment Factor and Alarm Response Rate population settings.

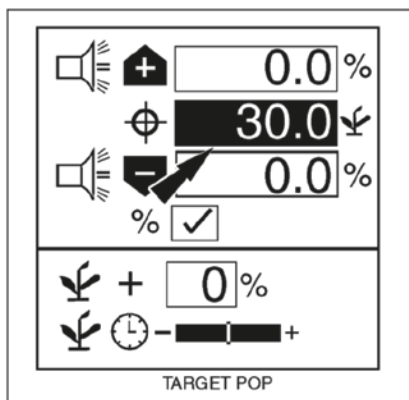

1. Select Target Population window. Target population is defined in 1000s of seeds per acre or hectare, dependent on the unit of measurement selected.

Note: If no value is entered, the monitor uses average population to calculate alarms or row population indicators. Press the **ENTER** key to select the window for editing.

2. Use the **LEFT** or **RIGHT ARROW** key to select a digit for editing. When a digit is highlighted, use the **up/down ARROW** keys to edit the value displayed.

Note! Always match the actual population listed in the ground drive sprocket selection chart as close as possible (for example 31,910 is the sprocket population so enter 31.9). *Do not enter "32.0."*

3. Drive to the end of the measured course at **3-8 km/h (2-5 mph)**. When the tractor is even with the end marker, press **ENTER** to stop the calibration.
4. Enter Maximum/minimum (over population/under population) settings.



DISPLAYS

EARLY RISER® IV DISPLAY (CONTINUED)

Planter Height Calibration (ERIV 1255/1250 FFT planters ONLY)

Two calibration set points must be calibrated to sense planter position and display accurately on the Toolbar Height Indicator located on the Frame Fold/Marker Controller SwitchBox.

- Down set point - When the toolbar is lowered to plant and the down set point is reached, the Controller triggers the start of a new cycle and allows the end-of-field set point to advance the next marker.
- End-of-Field set point - This set point performs a function in plant mode and during an unfold sequence mode.
 - Plant mode- when the toolbar is raised to end-of-field set point, the auto advance feature energizes the next marker to lower.
 - Unfold sequence, when the set point is reached, solenoids are disengaged and the planter will not lower past the end-of-field set point to ensure the planter does not lower all the way to the ground.



To calibrate the planter height:

1. Unfold the planter.
2. Simultaneously press and hold the Right Marker and Section 2 switches for 3 seconds to enter height calibration mode. In this mode, the Plant, Right Marker, and Section 2 LED's will flash. The Fold/Unfold Control Switch LED is solid ON.
3. To store the Planter Down position, engage hydraulics to fully lower toolbar and then press the Unfold/Next switch.
4. To store the End-of-Field position, engage hydraulics to raise the toolbar. Toolbar will stop raising by itself. Press the Left Marker switch.
5. After calibration, the correct planter position should accurately display on the Toolbar Height Indicator during Plant mode when the planter is raised and lowered.

To exit the calibration mode without making any changes, turn the Master Control Switch to OFF.

1200 SERIES EARLY RISER® PLANTER

DISPLAYS

AFS PRO 600/700 NAVIGATION

Large Tractor

TOOLBOX	DIAGNOSTICS	REMOTE VALVES																																																																																																																																																																																																																																																																																						
<p>DISPLAY</p> <table border="1"> <tr><td>Month</td><td>Day</td></tr> <tr><td>Year</td><td>Day/Night ▼</td></tr> <tr><td>Hour</td><td>Minute</td></tr> <tr><td>Language</td><td>Interface Level ▼</td></tr> <tr><td>Day/Night Backlight</td><td>Current Vehicle</td></tr> </table> <p>OPERATOR</p> <table border="1"> <tr><td>Operator</td><td></td></tr> <tr><td>Units ▼</td><td>Display Mode ▼</td></tr> <tr><td>Gridlines ▼</td><td>Date Format ▼</td></tr> <tr><td>Time Format ▼</td><td>Decimal Symbol ▼</td></tr> <tr><td>Display Volume</td><td></td></tr> </table> <p>LAYOUT</p> <table border="1"> <tr><td>Current Layout</td><td></td></tr> <tr><td>Run Screen ▼</td><td>Number of Windows ▼</td></tr> <tr><td>Option</td><td>Option</td></tr> <tr><td>Option</td><td>Option</td></tr> <tr><td>Option</td><td>Option</td></tr> <tr><td>Option</td><td>Option</td></tr> <tr><td>Option</td><td>Option</td></tr> </table> <p>SERVICE</p> <table border="1"> <tr><td>Engine Hours</td><td>Driveline Hours</td></tr> </table> <p>IMPLEMENT</p> <table border="1"> <tr><td></td><td>Implement</td></tr> <tr><td></td><td>Work Condition</td></tr> <tr><td></td><td>Implement Type</td></tr> <tr><td>Impl. Width</td><td>Swath Width</td></tr> <tr><td>Impl. Offset</td><td>Max Steer Angle</td></tr> </table> <p>VEHICLE</p> <table border="1"> <tr><td>Current Vehicle</td><td>P.I.N.</td></tr> <tr><td></td><td>Vehicle Name</td></tr> </table> <p>TRACTOR</p> <p>Driveline</p> <table border="1"> <tr><td>APM Sensitivity</td></tr> <tr><td>Auto Trans Lower Gear</td></tr> </table> <p>Settings</p> <table border="1"> <tr><td>Slip</td></tr> <tr><td>Slip Limit %</td></tr> </table> <p>Auto PTO</p> <table border="1"> <tr><td>Rear PTO Engage</td></tr> <tr><td>Rear PTO Disengage</td></tr> </table> <p>GPS</p> <table border="1"> <tr><td>GPS Location ▼</td><td>Connection Type ▼ [1]</td></tr> <tr><td>Logging Interval [1]</td><td>DGPS Alarm ▼ [1]</td></tr> <tr><td>DGPS Type ▼ [2]</td><td>Forward Offset [1]</td></tr> <tr><td>DGPS Backup ▼ [2]</td><td>Right Offset [1]</td></tr> <tr><td>Position Recall ▼ [2]</td><td>Height Offset [1]</td></tr> <tr><td>Converge Status [2]</td><td>Coverage Distance [2]</td></tr> <tr><td>Bound. Alarm Audio</td><td>Obst Alarm Audio</td></tr> <tr><td>Alarm Look Ahead</td><td></td></tr> </table> <p>PF</p> <table border="1"> <tr><td>Season Setup ▼</td><td>Obst. Alarm Audio ▼</td></tr> <tr><td>Bound. Alarm Audio ▼</td><td></td></tr> <tr><td>Alarm Look Ahead</td><td></td></tr> <tr><td>Bound. Auto-Complete</td><td></td></tr> </table> <p>MARKS (GPS must be installed)</p> <table border="1"> <tr><td>Field Mark 1</td><td>Button Type 1 [1]</td></tr> <tr><td>Field Mark 2</td><td>Button Type 2 [1]</td></tr> <tr><td>Field Mark 3</td><td>Button Type 3 [1]</td></tr> <tr><td>Field Mark 4</td><td>Button Type 4 [1]</td></tr> </table> <p>NAV</p> <table border="1"> <tr><td>NAV II Installed ▼</td><td>Min Turning Radius [1]</td></tr> <tr><td>Swath Finder Mode [1]</td><td>Nudge/Trim Increment [1]</td></tr> <tr><td>Swath Finder Range [1]</td><td>Aggressiveness [1]</td></tr> <tr><td>Swath Finder Time [1]</td><td>Swath Acquisition [1]</td></tr> <tr><td>NEMA Output Set [1]</td><td>NEMA Message Set [1]</td></tr> </table> <p>CONFIG</p> <table border="1"> <tr><td>Section 1 Rows</td><td>Markers ▼</td></tr> <tr><td>Section 2 Rows [4]</td><td>Liquid Product ▼</td></tr> <tr><td>Section 3 Rows [4]</td><td>Coilover Bar ▼</td></tr> <tr><td>Section 4 Rows [4]</td><td>Gran Chem Level ▼</td></tr> <tr><td>Row Width</td><td>Bulk Fill ▼</td></tr> <tr><td>Bar Distance</td><td>Left Speed Sensor [4]</td></tr> <tr><td>Advanced Settings ▼</td><td>Down Force Ctrl ▼ [8]</td></tr> <tr><td>Row/Clutch Group [1]</td><td>Row Clutch Control ▼</td></tr> <tr><td>Outer Group Size [2]</td><td>Bulk Fill Lighths ▼ [8]</td></tr> <tr><td>Split Installed ▼</td><td>Steering Wheels ▼ [8]</td></tr> </table> <p>Adv Set [6]</p> <table border="1"> <tr><td>Implement</td><td>Clutch Output Offset</td></tr> <tr><td>Seed Sect 1 [4]</td><td>Liquid Gain</td></tr> <tr><td>Seed Sect 2 [4]</td><td>Vacuum 1</td></tr> <tr><td>Seed Sect 3 [4]</td><td>Vacuum 2 [4]</td></tr> <tr><td>Seed Sect 4 [4]</td><td>Bulk Fill [6]</td></tr> <tr><td>Dn Pressure Up Gain</td><td>Dn Pressure Dn Gain</td></tr> </table> <p>ACTIVATE</p> <table border="1"> <tr><td>Display Serial Number</td></tr> <tr><td>Activation Code</td></tr> <tr><td>Name</td><td>Status</td></tr> </table> <p>MANUAL</p> <table border="1"> <tr><td>Control Channel</td></tr> <tr><td>Product Form ▼</td></tr> <tr><td>Link to Layout ▼</td><td>Number Sections</td></tr> <tr><td>Section 1 Width</td><td>Section 1 X Offset</td></tr> <tr><td></td><td>Section 1 Y Offset</td></tr> <tr><td>Section 2 Width [4]</td><td>Section 2 X Offset [4]</td></tr> <tr><td></td><td>Section 2 Y Offset [4]</td></tr> <tr><td>Section 3 Width [4]</td><td>Section 3 X Offset [4]</td></tr> <tr><td></td><td>Section 3 Y Offset [4]</td></tr> <tr><td>Section 4 Width [4]</td><td>Section 4 X Offset [4]</td></tr> <tr><td></td><td>Section 4 Y Offset [4]</td></tr> </table> <p>Toolbox cont. in next column</p>	Month	Day	Year	Day/Night ▼	Hour	Minute	Language	Interface Level ▼	Day/Night Backlight	Current Vehicle	Operator		Units ▼	Display Mode ▼	Gridlines ▼	Date Format ▼	Time Format ▼	Decimal Symbol ▼	Display Volume		Current Layout		Run Screen ▼	Number of Windows ▼	Option	Option	Option	Option	Option	Option	Option	Option	Option	Option	Engine Hours	Driveline Hours		Implement		Work Condition		Implement Type	Impl. Width	Swath Width	Impl. Offset	Max Steer Angle	Current Vehicle	P.I.N.		Vehicle Name	APM Sensitivity	Auto Trans Lower Gear	Slip	Slip Limit %	Rear PTO Engage	Rear PTO Disengage	GPS Location ▼	Connection Type ▼ [1]	Logging Interval [1]	DGPS Alarm ▼ [1]	DGPS Type ▼ [2]	Forward Offset [1]	DGPS Backup ▼ [2]	Right Offset [1]	Position Recall ▼ [2]	Height Offset [1]	Converge Status [2]	Coverage Distance [2]	Bound. Alarm Audio	Obst Alarm Audio	Alarm Look Ahead		Season Setup ▼	Obst. Alarm Audio ▼	Bound. Alarm Audio ▼		Alarm Look Ahead		Bound. Auto-Complete		Field Mark 1	Button Type 1 [1]	Field Mark 2	Button Type 2 [1]	Field Mark 3	Button Type 3 [1]	Field Mark 4	Button Type 4 [1]	NAV II Installed ▼	Min Turning Radius [1]	Swath Finder Mode [1]	Nudge/Trim Increment [1]	Swath Finder Range [1]	Aggressiveness [1]	Swath Finder Time [1]	Swath Acquisition [1]	NEMA Output Set [1]	NEMA Message Set [1]	Section 1 Rows	Markers ▼	Section 2 Rows [4]	Liquid Product ▼	Section 3 Rows [4]	Coilover Bar ▼	Section 4 Rows [4]	Gran Chem Level ▼	Row Width	Bulk Fill ▼	Bar Distance	Left Speed Sensor [4]	Advanced Settings ▼	Down Force Ctrl ▼ [8]	Row/Clutch Group [1]	Row Clutch Control ▼	Outer Group Size [2]	Bulk Fill Lighths ▼ [8]	Split Installed ▼	Steering Wheels ▼ [8]	Implement	Clutch Output Offset	Seed Sect 1 [4]	Liquid Gain	Seed Sect 2 [4]	Vacuum 1	Seed Sect 3 [4]	Vacuum 2 [4]	Seed Sect 4 [4]	Bulk Fill [6]	Dn Pressure Up Gain	Dn Pressure Dn Gain	Display Serial Number	Activation Code	Name	Status	Control Channel	Product Form ▼	Link to Layout ▼	Number Sections	Section 1 Width	Section 1 X Offset		Section 1 Y Offset	Section 2 Width [4]	Section 2 X Offset [4]		Section 2 Y Offset [4]	Section 3 Width [4]	Section 3 X Offset [4]		Section 3 Y Offset [4]	Section 4 Width [4]	Section 4 X Offset [4]		Section 4 Y Offset [4]	<p>Toolbox cont.</p> <p>PRODUCT</p> <table border="1"> <tr><td>Product Name</td><td>Form ▼ [1]</td></tr> <tr><td>Usage ▼ [1, 2]</td><td>Crop ▼ [2]</td></tr> <tr><td>Default App Rate [1]</td><td>Delta App Rate [1]</td></tr> <tr><td>Min App Rate [1]</td><td>Max App Rate [1]</td></tr> <tr><td>Package Size [3]</td><td>RX Scale Factor</td></tr> <tr><td>Product Density [3]</td><td>Unit Density [3]</td></tr> <tr><td>EPN Number [3]</td><td>Manufacturer [3]</td></tr> <tr><td>Restricted Use ▼ [3]</td><td>Posting Required ▼ [3]</td></tr> <tr><td>Buffer Distance [3]</td><td>Max Wind Speed [3]</td></tr> <tr><td>Mixture [3]</td><td>Mix Type ▼ [1], [3]</td></tr> <tr><td>Num of Products [1], [3]</td><td>Total Mix Amount [1], [3]</td></tr> <tr><td>Product 1 or *</td><td>Product 1 (*) Amount</td></tr> </table> <p>CONTNR</p> <table border="1"> <tr><td>Container</td><td>Type ▼</td></tr> <tr><td>Capacity</td><td>Level</td></tr> <tr><td>Warning Type ▼</td><td>Warning Level</td></tr> <tr><td>Time Tracking</td><td>Container Override</td></tr> </table> <p>OVERLAP</p> <table border="1"> <tr><td>Overlap Control</td><td>Boundary Control</td></tr> <tr><td>Percent out of Bounds</td><td></td></tr> <tr><td>Percent Overlap</td><td></td></tr> <tr><td>Start Early Distance</td><td></td></tr> <tr><td>Stop Late Distance</td><td></td></tr> </table> <p>RAVEN (if Equipped)</p> <table border="1"> <tr><td>Control Channel</td><td></td></tr> <tr><td>Area Limit</td><td>Valve</td></tr> <tr><td>Use Work State</td><td>SCS Series</td></tr> <tr><td>Product Form 1</td><td>Product Form 2</td></tr> <tr><td>Product Form 3</td><td>Look Ahead</td></tr> <tr><td>Number Booms</td><td></td></tr> <tr><td>Boom 1 Width</td><td>Boom 1 Fwd Offset</td></tr> <tr><td>Boom 1 On/Off</td><td>Boom 1 Right Offset</td></tr> <tr><td>Boom 2 Width</td><td>Boom 2 Fwd Offset</td></tr> <tr><td>Boom 2 On/Off</td><td>Boom 2 Right Offset</td></tr> <tr><td>Boom 3 Width</td><td>Boom 3 Fwd Offset</td></tr> <tr><td>Boom 3 On/Off</td><td>Boom 3 Right Offset</td></tr> </table> <p>RAWSON (if Equipped)</p> <table border="1"> <tr><td>Control Channel</td><td></td></tr> <tr><td>Product Form</td><td>Use Work State</td></tr> <tr><td>Delta %</td><td>Use Auto Section</td></tr> <tr><td>Look Ahead</td><td></td></tr> <tr><td>Section Width</td><td>Section Fwd Offset</td></tr> <tr><td>Section On/Off</td><td>Section Right Offset</td></tr> </table> <p>3rdCtrl (if equipped)</p> <table border="1"> <tr><td>Com-A</td><td>Com-B</td></tr> <tr><td></td><td></td></tr> <tr><td>Control Option</td><td></td></tr> </table>	Product Name	Form ▼ [1]	Usage ▼ [1, 2]	Crop ▼ [2]	Default App Rate [1]	Delta App Rate [1]	Min App Rate [1]	Max App Rate [1]	Package Size [3]	RX Scale Factor	Product Density [3]	Unit Density [3]	EPN Number [3]	Manufacturer [3]	Restricted Use ▼ [3]	Posting Required ▼ [3]	Buffer Distance [3]	Max Wind Speed [3]	Mixture [3]	Mix Type ▼ [1], [3]	Num of Products [1], [3]	Total Mix Amount [1], [3]	Product 1 or *	Product 1 (*) Amount	Container	Type ▼	Capacity	Level	Warning Type ▼	Warning Level	Time Tracking	Container Override	Overlap Control	Boundary Control	Percent out of Bounds		Percent Overlap		Start Early Distance		Stop Late Distance		Control Channel		Area Limit	Valve	Use Work State	SCS Series	Product Form 1	Product Form 2	Product Form 3	Look Ahead	Number Booms		Boom 1 Width	Boom 1 Fwd Offset	Boom 1 On/Off	Boom 1 Right Offset	Boom 2 Width	Boom 2 Fwd Offset	Boom 2 On/Off	Boom 2 Right Offset	Boom 3 Width	Boom 3 Fwd Offset	Boom 3 On/Off	Boom 3 Right Offset	Control Channel		Product Form	Use Work State	Delta %	Use Auto Section	Look Ahead		Section Width	Section Fwd Offset	Section On/Off	Section Right Offset	Com-A	Com-B			Control Option		<p>VERSION</p> <p>CAN</p> <p>FAULT</p> <table border="1"> <tr><td>Fault Archive</td></tr> </table> <p>RES (Data Card Information)</p> <table border="1"> <tr><td>Casters 1, 2, 3, 4 [8]</td></tr> </table> <p>GPS</p> <p>GPS 2 (must have Case IH or Trimble receiver present)</p> <p>RDI (must have Case IH or Trimble receiver present)</p> <p>PLANTER (Display Restart Button)</p> <p>COUNT</p> <table border="1"> <tr><td>Start/Stop Count</td><td>Reset Counts</td></tr> </table> <p>SENSOR</p> <p>SPEED</p> <table border="1"> <tr><td>Speed in Use</td><td>Source in Use</td></tr> <tr><td>Speed Priority ▼</td><td>Planter's Choice</td></tr> <tr><td>Left Wheel</td><td>Left Whl Health</td></tr> <tr><td>Right Wheel</td><td>Right Whl Health</td></tr> <tr><td>Radar</td><td></td></tr> <tr><td>GPS</td><td></td></tr> </table> <p>CLUTCH</p> <table border="1"> <tr><td>View Mode ▼</td><td></td></tr> <tr><td>Rows</td><td></td></tr> </table> <p>SIGNALS</p> <table border="1"> <tr><td>Parameter Group ▼</td><td></td></tr> <tr><td>Parameter ▼</td><td></td></tr> <tr><td>Signal Information</td><td></td></tr> </table> <p>STEERING [5], [8]</p> <table border="1"> <tr><td>Diagnostics Mode ▼</td><td>Impl Steer Angle</td></tr> <tr><td>Press Sensor PS</td><td>Press Sensor PS1</td></tr> <tr><td>Solenoid Control</td><td>Solenoid Feedback</td></tr> <tr><td>Solenoid #8</td><td>Solenoid #8 On/Off</td></tr> <tr><td>Solenoid #9</td><td>Solenoid #9 On/Off</td></tr> <tr><td>Solenoid #10</td><td>Solenoid #10 On/Off</td></tr> <tr><td>Solenoid #11</td><td>Solenoid #11 On/Off</td></tr> </table>	Fault Archive	Casters 1, 2, 3, 4 [8]	Start/Stop Count	Reset Counts	Speed in Use	Source in Use	Speed Priority ▼	Planter's Choice	Left Wheel	Left Whl Health	Right Wheel	Right Whl Health	Radar		GPS		View Mode ▼		Rows		Parameter Group ▼		Parameter ▼		Signal Information		Diagnostics Mode ▼	Impl Steer Angle	Press Sensor PS	Press Sensor PS1	Solenoid Control	Solenoid Feedback	Solenoid #8	Solenoid #8 On/Off	Solenoid #9	Solenoid #9 On/Off	Solenoid #10	Solenoid #10 On/Off	Solenoid #11	Solenoid #11 On/Off
Month	Day																																																																																																																																																																																																																																																																																							
Year	Day/Night ▼																																																																																																																																																																																																																																																																																							
Hour	Minute																																																																																																																																																																																																																																																																																							
Language	Interface Level ▼																																																																																																																																																																																																																																																																																							
Day/Night Backlight	Current Vehicle																																																																																																																																																																																																																																																																																							
Operator																																																																																																																																																																																																																																																																																								
Units ▼	Display Mode ▼																																																																																																																																																																																																																																																																																							
Gridlines ▼	Date Format ▼																																																																																																																																																																																																																																																																																							
Time Format ▼	Decimal Symbol ▼																																																																																																																																																																																																																																																																																							
Display Volume																																																																																																																																																																																																																																																																																								
Current Layout																																																																																																																																																																																																																																																																																								
Run Screen ▼	Number of Windows ▼																																																																																																																																																																																																																																																																																							
Option	Option																																																																																																																																																																																																																																																																																							
Option	Option																																																																																																																																																																																																																																																																																							
Option	Option																																																																																																																																																																																																																																																																																							
Option	Option																																																																																																																																																																																																																																																																																							
Option	Option																																																																																																																																																																																																																																																																																							
Engine Hours	Driveline Hours																																																																																																																																																																																																																																																																																							
	Implement																																																																																																																																																																																																																																																																																							
	Work Condition																																																																																																																																																																																																																																																																																							
	Implement Type																																																																																																																																																																																																																																																																																							
Impl. Width	Swath Width																																																																																																																																																																																																																																																																																							
Impl. Offset	Max Steer Angle																																																																																																																																																																																																																																																																																							
Current Vehicle	P.I.N.																																																																																																																																																																																																																																																																																							
	Vehicle Name																																																																																																																																																																																																																																																																																							
APM Sensitivity																																																																																																																																																																																																																																																																																								
Auto Trans Lower Gear																																																																																																																																																																																																																																																																																								
Slip																																																																																																																																																																																																																																																																																								
Slip Limit %																																																																																																																																																																																																																																																																																								
Rear PTO Engage																																																																																																																																																																																																																																																																																								
Rear PTO Disengage																																																																																																																																																																																																																																																																																								
GPS Location ▼	Connection Type ▼ [1]																																																																																																																																																																																																																																																																																							
Logging Interval [1]	DGPS Alarm ▼ [1]																																																																																																																																																																																																																																																																																							
DGPS Type ▼ [2]	Forward Offset [1]																																																																																																																																																																																																																																																																																							
DGPS Backup ▼ [2]	Right Offset [1]																																																																																																																																																																																																																																																																																							
Position Recall ▼ [2]	Height Offset [1]																																																																																																																																																																																																																																																																																							
Converge Status [2]	Coverage Distance [2]																																																																																																																																																																																																																																																																																							
Bound. Alarm Audio	Obst Alarm Audio																																																																																																																																																																																																																																																																																							
Alarm Look Ahead																																																																																																																																																																																																																																																																																								
Season Setup ▼	Obst. Alarm Audio ▼																																																																																																																																																																																																																																																																																							
Bound. Alarm Audio ▼																																																																																																																																																																																																																																																																																								
Alarm Look Ahead																																																																																																																																																																																																																																																																																								
Bound. Auto-Complete																																																																																																																																																																																																																																																																																								
Field Mark 1	Button Type 1 [1]																																																																																																																																																																																																																																																																																							
Field Mark 2	Button Type 2 [1]																																																																																																																																																																																																																																																																																							
Field Mark 3	Button Type 3 [1]																																																																																																																																																																																																																																																																																							
Field Mark 4	Button Type 4 [1]																																																																																																																																																																																																																																																																																							
NAV II Installed ▼	Min Turning Radius [1]																																																																																																																																																																																																																																																																																							
Swath Finder Mode [1]	Nudge/Trim Increment [1]																																																																																																																																																																																																																																																																																							
Swath Finder Range [1]	Aggressiveness [1]																																																																																																																																																																																																																																																																																							
Swath Finder Time [1]	Swath Acquisition [1]																																																																																																																																																																																																																																																																																							
NEMA Output Set [1]	NEMA Message Set [1]																																																																																																																																																																																																																																																																																							
Section 1 Rows	Markers ▼																																																																																																																																																																																																																																																																																							
Section 2 Rows [4]	Liquid Product ▼																																																																																																																																																																																																																																																																																							
Section 3 Rows [4]	Coilover Bar ▼																																																																																																																																																																																																																																																																																							
Section 4 Rows [4]	Gran Chem Level ▼																																																																																																																																																																																																																																																																																							
Row Width	Bulk Fill ▼																																																																																																																																																																																																																																																																																							
Bar Distance	Left Speed Sensor [4]																																																																																																																																																																																																																																																																																							
Advanced Settings ▼	Down Force Ctrl ▼ [8]																																																																																																																																																																																																																																																																																							
Row/Clutch Group [1]	Row Clutch Control ▼																																																																																																																																																																																																																																																																																							
Outer Group Size [2]	Bulk Fill Lighths ▼ [8]																																																																																																																																																																																																																																																																																							
Split Installed ▼	Steering Wheels ▼ [8]																																																																																																																																																																																																																																																																																							
Implement	Clutch Output Offset																																																																																																																																																																																																																																																																																							
Seed Sect 1 [4]	Liquid Gain																																																																																																																																																																																																																																																																																							
Seed Sect 2 [4]	Vacuum 1																																																																																																																																																																																																																																																																																							
Seed Sect 3 [4]	Vacuum 2 [4]																																																																																																																																																																																																																																																																																							
Seed Sect 4 [4]	Bulk Fill [6]																																																																																																																																																																																																																																																																																							
Dn Pressure Up Gain	Dn Pressure Dn Gain																																																																																																																																																																																																																																																																																							
Display Serial Number																																																																																																																																																																																																																																																																																								
Activation Code																																																																																																																																																																																																																																																																																								
Name	Status																																																																																																																																																																																																																																																																																							
Control Channel																																																																																																																																																																																																																																																																																								
Product Form ▼																																																																																																																																																																																																																																																																																								
Link to Layout ▼	Number Sections																																																																																																																																																																																																																																																																																							
Section 1 Width	Section 1 X Offset																																																																																																																																																																																																																																																																																							
	Section 1 Y Offset																																																																																																																																																																																																																																																																																							
Section 2 Width [4]	Section 2 X Offset [4]																																																																																																																																																																																																																																																																																							
	Section 2 Y Offset [4]																																																																																																																																																																																																																																																																																							
Section 3 Width [4]	Section 3 X Offset [4]																																																																																																																																																																																																																																																																																							
	Section 3 Y Offset [4]																																																																																																																																																																																																																																																																																							
Section 4 Width [4]	Section 4 X Offset [4]																																																																																																																																																																																																																																																																																							
	Section 4 Y Offset [4]																																																																																																																																																																																																																																																																																							
Product Name	Form ▼ [1]																																																																																																																																																																																																																																																																																							
Usage ▼ [1, 2]	Crop ▼ [2]																																																																																																																																																																																																																																																																																							
Default App Rate [1]	Delta App Rate [1]																																																																																																																																																																																																																																																																																							
Min App Rate [1]	Max App Rate [1]																																																																																																																																																																																																																																																																																							
Package Size [3]	RX Scale Factor																																																																																																																																																																																																																																																																																							
Product Density [3]	Unit Density [3]																																																																																																																																																																																																																																																																																							
EPN Number [3]	Manufacturer [3]																																																																																																																																																																																																																																																																																							
Restricted Use ▼ [3]	Posting Required ▼ [3]																																																																																																																																																																																																																																																																																							
Buffer Distance [3]	Max Wind Speed [3]																																																																																																																																																																																																																																																																																							
Mixture [3]	Mix Type ▼ [1], [3]																																																																																																																																																																																																																																																																																							
Num of Products [1], [3]	Total Mix Amount [1], [3]																																																																																																																																																																																																																																																																																							
Product 1 or *	Product 1 (*) Amount																																																																																																																																																																																																																																																																																							
Container	Type ▼																																																																																																																																																																																																																																																																																							
Capacity	Level																																																																																																																																																																																																																																																																																							
Warning Type ▼	Warning Level																																																																																																																																																																																																																																																																																							
Time Tracking	Container Override																																																																																																																																																																																																																																																																																							
Overlap Control	Boundary Control																																																																																																																																																																																																																																																																																							
Percent out of Bounds																																																																																																																																																																																																																																																																																								
Percent Overlap																																																																																																																																																																																																																																																																																								
Start Early Distance																																																																																																																																																																																																																																																																																								
Stop Late Distance																																																																																																																																																																																																																																																																																								
Control Channel																																																																																																																																																																																																																																																																																								
Area Limit	Valve																																																																																																																																																																																																																																																																																							
Use Work State	SCS Series																																																																																																																																																																																																																																																																																							
Product Form 1	Product Form 2																																																																																																																																																																																																																																																																																							
Product Form 3	Look Ahead																																																																																																																																																																																																																																																																																							
Number Booms																																																																																																																																																																																																																																																																																								
Boom 1 Width	Boom 1 Fwd Offset																																																																																																																																																																																																																																																																																							
Boom 1 On/Off	Boom 1 Right Offset																																																																																																																																																																																																																																																																																							
Boom 2 Width	Boom 2 Fwd Offset																																																																																																																																																																																																																																																																																							
Boom 2 On/Off	Boom 2 Right Offset																																																																																																																																																																																																																																																																																							
Boom 3 Width	Boom 3 Fwd Offset																																																																																																																																																																																																																																																																																							
Boom 3 On/Off	Boom 3 Right Offset																																																																																																																																																																																																																																																																																							
Control Channel																																																																																																																																																																																																																																																																																								
Product Form	Use Work State																																																																																																																																																																																																																																																																																							
Delta %	Use Auto Section																																																																																																																																																																																																																																																																																							
Look Ahead																																																																																																																																																																																																																																																																																								
Section Width	Section Fwd Offset																																																																																																																																																																																																																																																																																							
Section On/Off	Section Right Offset																																																																																																																																																																																																																																																																																							
Com-A	Com-B																																																																																																																																																																																																																																																																																							
Control Option																																																																																																																																																																																																																																																																																								
Fault Archive																																																																																																																																																																																																																																																																																								
Casters 1, 2, 3, 4 [8]																																																																																																																																																																																																																																																																																								
Start/Stop Count	Reset Counts																																																																																																																																																																																																																																																																																							
Speed in Use	Source in Use																																																																																																																																																																																																																																																																																							
Speed Priority ▼	Planter's Choice																																																																																																																																																																																																																																																																																							
Left Wheel	Left Whl Health																																																																																																																																																																																																																																																																																							
Right Wheel	Right Whl Health																																																																																																																																																																																																																																																																																							
Radar																																																																																																																																																																																																																																																																																								
GPS																																																																																																																																																																																																																																																																																								
View Mode ▼																																																																																																																																																																																																																																																																																								
Rows																																																																																																																																																																																																																																																																																								
Parameter Group ▼																																																																																																																																																																																																																																																																																								
Parameter ▼																																																																																																																																																																																																																																																																																								
Signal Information																																																																																																																																																																																																																																																																																								
Diagnostics Mode ▼	Impl Steer Angle																																																																																																																																																																																																																																																																																							
Press Sensor PS	Press Sensor PS1																																																																																																																																																																																																																																																																																							
Solenoid Control	Solenoid Feedback																																																																																																																																																																																																																																																																																							
Solenoid #8	Solenoid #8 On/Off																																																																																																																																																																																																																																																																																							
Solenoid #9	Solenoid #9 On/Off																																																																																																																																																																																																																																																																																							
Solenoid #10	Solenoid #10 On/Off																																																																																																																																																																																																																																																																																							
Solenoid #11	Solenoid #11 On/Off																																																																																																																																																																																																																																																																																							

- [1] - Dependent on original option specified on screen
- [2] - Dependent on secondary option specified on screen
- [3] - Dependent on operator interface level (basic or advanced)
- [4] - Dependent on planter type or number of sections specified
- [5] - Dependent on planter configurations specified on TOOLBOX > CONFIG screen
- [6] - Dependent on whether "Advanced Setups" is set to "YES" on TOOLBOX > CONFIG screen
- [7] - Dependent on whether "Row Clutch Control" is set to "YES" on TOOLBOX > CONFIG screen
- [8] - Available on Early Riser 1260/65 only



PERFORMANCE

PROD

Work Rate	Target Rate
Area Worked	Target Rate
Time to Completion	
Distance	Dist In Work

INSTANT

Work Rate	Engine Load
Fuel/Hour	Fuel/Dist
Fuel/Area	Fuel/Econ
Slip	

RANGE

Distance Left	
Time Left	
Area Left	

OVERALL

Task	Area
Distance, Work	Work Rt, Wrk, Avg

PROFILE

Grower	Tag
Farm	Implement
Field	
Task	
Crop Type	

SUM1

Summary Crop	
Summary Tag	Work Rate, Avg
Summary Grower	Time, Worked
Summary Farm	
Summary Field	Distance
Summary Task	

SUM2

Summary Crop	
Summary Tag	
Summary Farm	
Summary Field	Distance, Road
Summary Task	
Work Rate, Avg	Time, Road

Rx SETUP

Grower	Farm
Field	Task
Layer 1	Prescription 1
Layer 2	Prescription 2
Layer 3	Prescription 3
Layer 4	Prescription 4
Layer 5	Prescription 5



RUN

RUN 1

Speed	Date/Time
Implement	Work Condition
Area Control	Distance
Work Control	Fuel Used
Operator	Engine Hours
Work Rate	Guidance Engage

RUN 2

Grower	Implement
Farm	Work Condition
Field	Operator
Task	Operation
Crop Type	Work Control
Tag	Swath Select

RUN 3

Swath 1 Record 2x1	
Swath Number	Swath Select
Swath Map	Nudge
	GRS Heading
	Cross Track Err
	Guidance Engage

RUN 4

Seed Control	Seed Scan
Vacuum Control	Vacuum Scan
Bulk Control	Bulk Rate
Liquid Control	Liquid Scan
Marker Control	Obstacle Control
Section 1/2	Section 3/4

RUN 5

Swath Finder 2x1	
Map 2x5	

RUN 6

Seed Control	Work Condition
Ground Speed	Row Scan
Prime Control	Bins, Seed
Marker Control	Obstacle Control
Seed Graph 2x2	

LEFT AREA (configurable)

End of Row Functions	
Engine Power	
Slip	
Fuel/Hour	
Work Rate	
Fuel Level	



Work Condition

HITCH

Implement	Work Condition
-----------	----------------

OPERATE (a work condition must be selected)

Implement	Work Condition
Row Disable	Graph Response
Auto Sect. Enable	Prime Speed
Minimum %	Planter Control
Maximum %	Speed Priority
Fault Speed	Boost Level
Stop Plant Beeps	
Intentional Overlap	Planter Swath Offset

CONTROL

Implement	Work Condition
Controller Select	
Default Rate	Alarm Limit
Delta Rate	Cal Value
Product Delay	

ROW

Implement	Work Condition
Row Width	View Mode
Rows	

SEED

Implement	Work Condition
Default Rate	Speed
Distance	Cal Value
Section Control	
Start/Stop	Section Status

LIQUID [5]

Implement	Work Condition
Default Rate	Speed
Start/Stop	
Target Per Nozzle	Measured
Actual Flow	Cal Value (L)

LAYER

Work Condition	
Layer 1	
Product 1	Container 1
Layer 2	
Product 2	Container 2
Layer 3	
Product 3	Container 3
Layer 4	
Product 4	Container 4
Layer 5	
Product 5	Container 5
Layer 6	
Product 6	Container 6
Layer 7	
Product 7	Container 7



ELECTRONIC EOR

MAIN

MANAGER

Implement	Sequence
	Download button



DATA MANAGEMENT

IMPORT

Data Type	Import
Vehicle Name	

FILTER

Filter Crop List	
------------------	--

DELETE

Data Type	Delete
Type	

Map

Coverage	
Field	Map Item
Boundry	



CALIBRATION

AREA

Grower	
Farm	
Field	
Operation	Operation Instance
Area	Error %
	Calibrate

NAV

Vehicle Model	
Calibration	
GPS Status	Cross Track Err Avg
Cross Track Err in.	Autoguidance Engage

DISTANCE

Actual Distance	Drive Course
Left Measured	Right Measured
Left Wheel Cal	Right Wheel Cal
Left Cal Value	Right Cal Value
Master Control	

FRAME [4]

SENSORS [8] (1260 Frame Calibration Wizard)

Description	
Calibration Type	Frame Cal Type [1]
Frame Position Bar	Last Saved
Graph	Caster Alignment
Help, Main Buttons	Cancel, Back, Proceed



WIZARDS

FULL SETUP

DISPLAYS

AFS PRO 600 AND AFS PRO 700 DISPLAYS

Introduction

The AFS Pro 600/700 displays from Case IH AFS is an integral part of the operation of the Early Riser Series Planters. AFS Pro 600/700 Displays control numerous planter operations and provides the operator with the ability to integrate a multitude of AFS Precision Farming features. GPS-driven planting and nutrition prescriptions can be used to fine-tune inputs to maximize profitability. Overlap Control and Boundary Control engage and disengage drives to minimize over-planting and maximize yield. AFS AccuStat (AFS Pro 700 only) provides instant feedback on seed singulation performance to make sure the job is done right.

Each Planter equipped with an AFS Pro 600/700 includes an Operator’s Manual much like you receive with any other piece of Case IH equipment. This manual should be used for specific information and procedures. The following information is for quick reference and reminder.

Requirements:

- The display should always have a data card (P/N - 84398840) installed before turning on the display. If no data card is installed, any data recorded while the display has no data card will be lost.

General Navigation

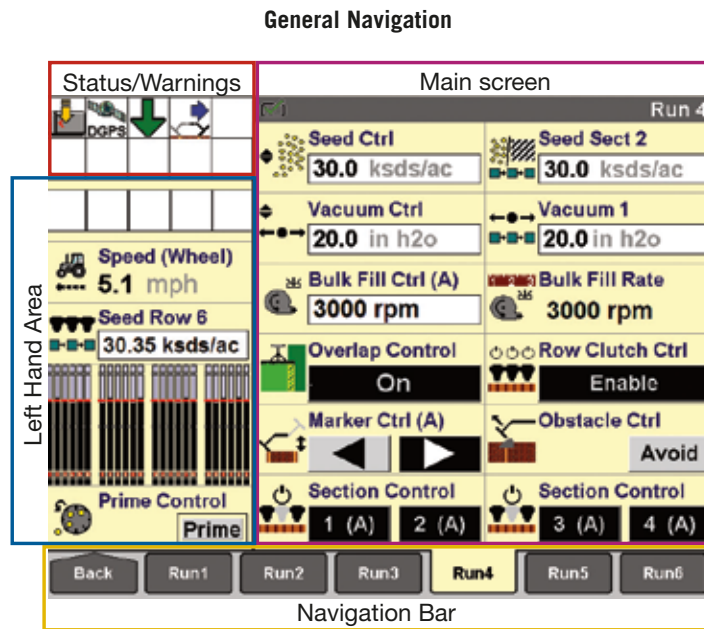

Main Screen



Toolbox – Display preferences and operator preferences, customizing run screens, GPS set-up, vehicle and implement set-up, etc.



Run – Access six customizable user screens for all applications.

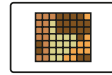

Performance – View Summaries & Assign Prescriptions (Rx).



Remote Valve – Fold/Unfold & adjust remote valve flows, timers, locks.



Calibration – Distance and Frame Cal.

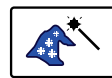

Wizard – Step-by-step planter set-up.



Work Condition – Store a group of vehicle or implement settings that could be based on crop type, products, weather conditions, or field conditions.

Set-Up

There are two methods to performing seasonal and day-to-day settings

1. Using Wizards (Recommended - Guides the user step-by-step through set-up)
2. Selecting each screen separately to set-up

DISPLAYS

AFS PRO 600 AND AFS PRO 700 DISPLAYS (CONTINUED)

Wizard

The “Full Setup” wizard provides a guided, step-by-step process for setting up the current planter with a focus on the operator’s specific operating requirements. The wizard greatly reduces the time and effort associated with planter setup by prompting the operator for information that would otherwise require navigating to numerous setup screens independently.

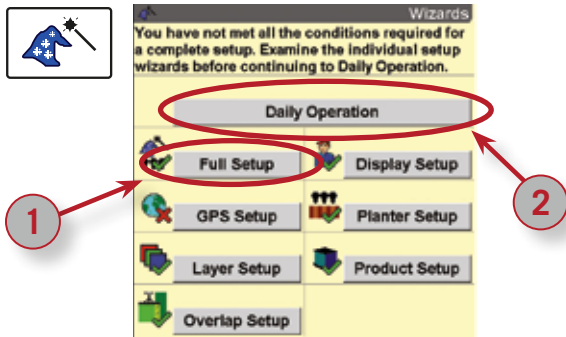

1. Select Wizards Button on Main/Home Screen (Back>Wizards).
2. Select “Full Setup” (1) to begin set-up process for the first time or if a crop type has been changed
3. Adjustments after first time full set-up is completed can be done by selecting the other set-up buttons available on the ‘Main’ screen (GPS Setup, etc)
4. Utilize the Daily Operation Wizard (2) to begin work each day (Fold, Unfold, begin planting & check basic set-up).

Run Screen Layout

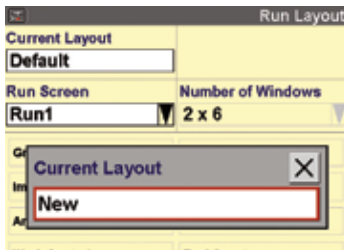

Toolbox > Layout

Adjust Run Screen Layout – Toolbox > Layout.

Create your own customized layout. Everyone on the farm can have their own layout, if desired.

GPS Set-up

Note: The following steps are also found in the Wizard based set-up.

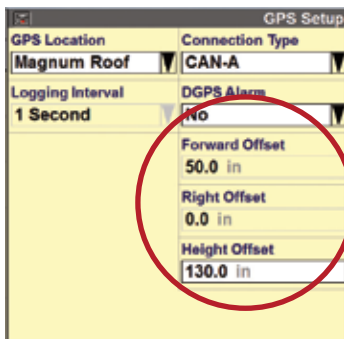

Toolbox>GPS>Forward Offset/Right OffSet/Height Offset

Measure/Check reference Point on Tractor – Verify GPS receiver position.

- MFWD - Rear Axle
- 4WD – Front Axle

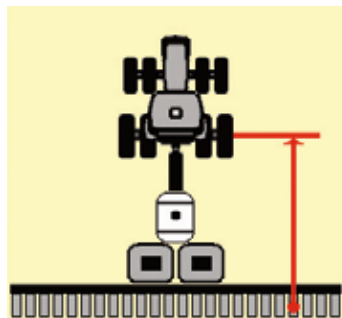

Toolbox>Config

Bar Distance – Position of Planter must be measured in relationship to a reference point on the tractor.

Do not adjust Bar Distance to adjust Overlap Control – Adjust Product Delay

DISPLAYS

AFS PRO 600 AND AFS PRO 700 DISPLAYS (CONTINUED)

As-Applied Mapping & Variety Tracking

Note: The following steps are also found in the Wizard based set-up.

Product Setup	
Product Name	Form
BRANDX	Seed
Crop	
Corn	
Default App Rate	Delta App Rate
34.0 kdsds/ac Units	1.0 kdsds/ac
Min App Rate	Max App Rate
0.0 kdsds/ac	34.0 kdsds/ac
Package Size	RX Scale Factor
56.00 lb Units	1 : 1.0000
Product Density	Unit Density
0.00 lb/gal Units	1428.57 sds/l Units

As-Applied Mapping allows the operator to map the application rate of the variety or product being applied as well as the placement of the variety in the field to reference during harvest. Up to 7 products can be mapped at one time.



(Toolbox>Product)

1. Create a Product (Variety or Fertilizer, etc) Note: Products can be created and exported using AFS software



(Work Condition>Layer)

2. Create a Work Condition, if needed (ex. Corn Planting)
3. Choose layer type (Seed, Seed Left, Seed Right, Liquid, etc.); Seed Left/Seed Right for split hybrid planting
4. Assign the Product to a Mapping Layer.
5. Assign additional products
6. Change the Product when changing the seed variety being planted.

Work Condition	
CORN-HIGH POPUL	
Layer 1	
Seed	
Product 1	Container 1
BRANDX	None
Layer 2	
Liquid	
Product 2	Container 2
10-34-0	None

Prescription Assignment

Prescription Setup	
Auto Reload Rx	Grower
Enabled	Case IH Farms
Farm	Field
Hempen Farm	North Field
Layer 1	Product 1
Seed	E1602SS
Prescription 1	Out Of Zone Rate 1
HEMPENS - Seed	34.0 kdsds/ac
Layer 2	Product 2
No Control	
Prescription 2	Out Of Zone Rate 2

Check Layer/Product set-up is complete (Work Condition>Layer)

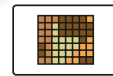

(Performance>Rx Setup)

1. Select Grower>Farm>Field
2. Assign Prescription (1) (If Prescription is not available verify Grower>Farm>Field and/or the prescription was exported properly (AFS Pro 700 requires Voyager 2 format only!)

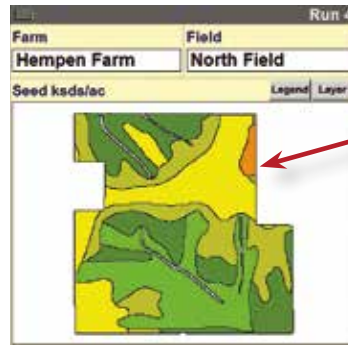

3. Verify 'Out of Prescription Zone Rate'
4. Prescription map (2) is available on the Run Screen Map (Note: Adjustment to the Legend and Layer menus may be needed to view zones)

Run 1	
Seed Ctrl (A)	Seed Sect Avg
34.0 kdsds/ac	----- kdsds/ac
Vacuum Ctrl	Vacuum 1
Seed Ctrl	
34.0	
Reset	
Auto	On
Enter	
Section Control	Section Control
1 (A)	2 (A)
3 (A)	4 (A)

5. Prescription is active during planting if (A) is next to 'Seed Ctrl' on the Run Screen.
6. Press 'Auto' button to Grey for manual rate control if prescription control is not desired.

DISPLAYS

AFS PRO 600 AND AFS PRO 700 DISPLAYS (CONTINUED)

Liquid & Seed Calibration

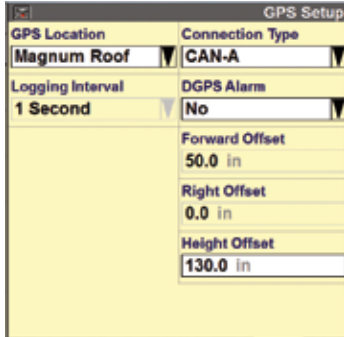

Work Condition > Liquid [Seed similar]

Calibration of the Liquid Fertilizer system is critical for accurate application rates. Follow the steps in the Wizard for calibration. Tips for use:

1. Verify target application rate.
2. Verify target planting speed.
3. Verify Cal value (L) on flowmeter (Liquid Only).
4. Press Run to arm the system.
5. Place measuring containers under fertilizer tubes.
6. Press and hold button switch on remote tether to run Cal. (1-2 min.).
7. (Liquid only) Enter in Actual Flow measured amount (lpm/gpm).
8. (Liquid Only) Press Cal button, repeat 3 times.

Frame Calibration



Calibration>Sensors>Frame Cal Type

Frame Calibration is critical for proper operation.

Calibrate each height position by raising or lowering planter to desired position and press 'Cal'. Individual positions can be recalibration at a later time, by selecting 'Frame Cal Type'

Speed/Distance Calibration

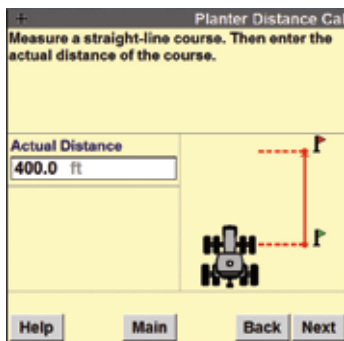

Calibration>Distance

The Speed/Distance Calibration calibrates the planter speed (wheel/radar) sensors and is critical for applying/recording proper application rates and acres. Follow the steps in the Wizard for calibration. Some helpful tips:

1. Perform with Seed Tanks ½ full & in field conditions
2. Mark out course at least 400 ft long.
3. Press start button at start of course.
4. Press stop button at end of course.
5. Press 'Cal'.
6. Repeat 4 times, average the Cal numbers and manually enter the Cal #.

DISPLAYS

AFS PRO 600 AND AFS PRO 700 DISPLAYS (CONTINUED)

Ground Speed Selection (AFS Pro 700 Only)

Ground speed source selection is available in v30.* and after Larger Tractor (Magnum 250 & larger and Steiger) software (Spring 2015). The sources available will be listed and can be chosen as a ground speed source by any planter model. If the desired source is not available it is likely that source is either not turned on or available at that time.

Note: The planter drives will not turn while traveling at under 1 mph.

Large Tractor Software



Toolbox>Speed>Speed Source

(available on a run screen as well)



- Tractor Wheel Speed



- Planter Wheel Speed



- Radar (if available)



- GPS (If available)

- Default (Defaults to source chosen by Planter in **Work Condition>Operate>Speed Priority**)



Speed Source Selection (GPS not shown)

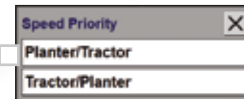

Note! The tractor wheel speed sensors must always be available/valid, no matter the Speed Priority. If no tractor wheel speed sensor is available, no planting will occur. Tractor wheel speed is used when traveling one (1) mph or under.

Medium Tractor Software (Puma & Magnum 180-



Work Condition>Speed>Speed Source



- Tractor Wheel Speed



- Planter Wheel Speed



- Radar (if available)



- GPS (If available)

- Default (Defaults to source chosen by Planter in **Work Condition>Operate>Speed Priority**)

Note! The tractor wheel speed sensors must always be available/valid, no matter the Speed Priority. If no tractor wheel speed sensor is available, no planting will occur. Tractor wheel speed is used when traveling one (1) mph or under.

Generic Tractor Software

(Prior to 2006 MX Magnum or STX Steiger & Competitive Tractors)

- Utilizes Speed Priority Set in **Work Condition>Operate**

Note! The planter wheel speed sensors must always be available/valid, no matter the Speed Priority. If no planter wheel speed sensors are available, no planting will occur. Planter wheel speed is used when traveling one (1) mph or under.

If Default is chosen the 1200PT, 1240/45, 1250/55 & 1260/65 planters have an option to choose different ground speed Priorities. 1210/1215, 1220/25 & 1230/1235 have set priorities and are not changeable. Use Toolbox>Speed to choose the speed source



Work Condition>Operate

Priority if “Planter/Tractor” selected, the software uses speed sources in this order of priority:

1. Planter or Tractor Wheel speed sensors if input is valid
2. Tractor radar if input is valid
3. GPS speed if input is valid

Priority if “Tractor/Planter” selected:

1. Tractor radar if input is valid
2. GPS speed if input is valid
3. Planter or Tractor Wheel speed if input is valid

DISPLAYS

AFS PRO 600 AND AFS PRO 700 DISPLAYS (CONTINUED)

Overlap/Boundary Control Settings (Sections and Accu-Row)

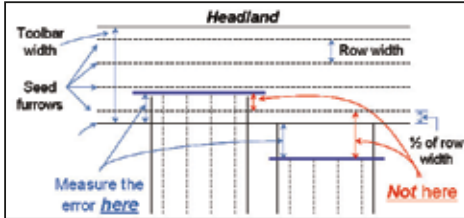

Recommended! All Boundary and Overlap Control settings can be adjusted and calculated using the Wizards. Information below is for reference.

Before making any adjustments to the Product Delay, make sure GPS offsets & Bar Distance, is entered correctly, Product are assigned to layer and a data card is in the display.

To check performance:

1. Test Overlap Performance at headland (keep a consistent speed!)
2. Measure the error (Distance between where seed SHOULD have been and where seed ACTUALLY is.)

Note! Final product delay adjustment should result in a gap from the first headland row (approx. 1/2 the row width)

3. Calculate the change in existing Product Delay (PD):

$$\text{change in PD (sec)} = \frac{\text{In. of error}}{\text{mph} \times 17.60}$$

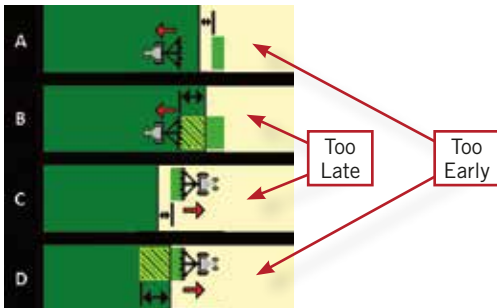

(Work Condition>Control>Seed)

Too Early = DECREASE PD by calculated amount

Too Late = INCREASE PD by calculated amount

4. Once Product Delay is set, adjustments can now be made to the Start Early/Stop Late Distances (1) if intentional overlap is desired. (**Toolbox>Overlap**)

Note: Start Early/Stop Late does not affect Boundary Control. Adjust Product Delay.



1200 SERIES EARLY RISER® PLANTER

DISPLAYS

AFS PRO 600 AND AFS PRO 700 DISPLAYS (CONTINUED)

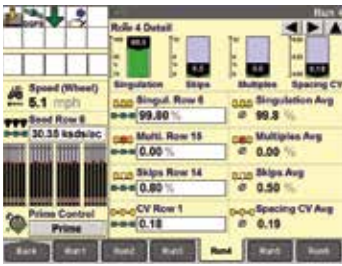

AFS AccuStat (AFS Pro 700 5 Series Planters only, Unlock Required)

1. View and record Singulation quality %, Multiples Scan, Skips Scan, CV Scan.
2. View graph comparing rows.
3. “Zoom” in on section or Row (shown) by pressing the section or row.



Toolbox>AcStat

1. Adjustable Color coded quality thresholds
 1. Green = Good
 2. Yellow = Average
 3. Red = Poor

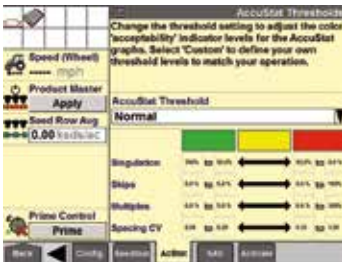

Troubleshooting Planter Performance

A **single row** is problematic:

- Singulator Adjustment/Failure
- Seed Disc Selection/Issue
- Seed Meter Drive (Chain, Clutch, AccuDrive Cable Issue)

An **entire section** is problematic:

- Section Drive Chain
- Hydraulic Component Issue/Failure
- Vacuum Distribution Issue

All rows/sections are problematic:

- Seed disc selection issue (ex. holes to close together and seed touching)
- Moist/sticky seed treatments
- Seed Flow Lubricant needed
- Incorrect Vacuum Level (use minimum setting)
- Residue manager settings (not plowing)
- Toolbar height (20 in.)
- Display settings (cells/disc setting, mech drive settings not exactly what book settings is)

EARLY RISER 1260/65 STEERABLE AXLE OPERATION

The 1260 and 1265 features a unique rear steering axle that allows the operator to control the position of the planter when turning a tight corner. The result is faster roading between fields and more time planting.

To use the rear steering axle:

- Assure Steering Axle Calibration has been performed (**Calibration>Sensors>Impl Steering>Last Saved**).

If it has not been calibrated or the axle is not centered after returning to center, use the calibration wizard to calibrate the steering axle (left/right/center positions).



Activate the steering axle by choosing:

Remote Valves>Planter Frame Operation>Steering and pressing **Manual**.











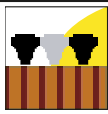







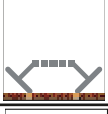
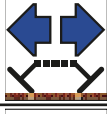
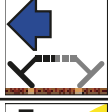

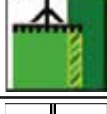

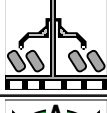
- Use the lift/lower/fold remote valve to steer the rear axle.
Note: The axle will be disabled above 9 mph.
- To recenter, activate the remote valve and press the **Reset** button.
Note: Auto-centering of the steering wheels will also take place when the planter is in “Plant” mode and the planter is raised at the headland turn.

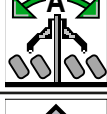
DISPLAYS

ICON LEGEND

Status and Vehicle Status Icons

The below tables provide a quick overview of the status or warning icons which may display in the status and warning icon area while planting.













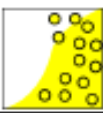





ICON	MEANING	ICON	MEANING
	A seed section is turned OFF.		A row seed sensor is faulty.
	The toolbar is in the fully raised position.		Distance calibration is in progress.
	A container level is low, or a container is empty.		A container level event is in progress for filing, refilling or flushing. Time, location and fill amount are being recorded.
	A seed bin level is low.		A granular chemical bin level is low.
	No marker is deployed.		Both markers are deployed
	The left marker is deployed.		The right marker is deployed
	The “Avoid” button or “Inner” button in the “Obstacle” window has been pressed to avoid an obstacle to a marker.		Automatic overlap control has turned product application OFF on one or more planter rows or sections.
	A row clutch is in “Manual” control mode. Any row clutch in “Manual” mode will not respond to automatic overlap control.		Implement steering is active.
	Implement steering is not available or is OFF.		The implement steering system is in automatic mode.
	The implement steering system is in manual mode.		The implement is raised.
	The implement is lowered.		Area control is turned OFF. No area, distance, or time information is accumulated for planting.
	The planter is roading. Area, distance, and time information is accumulating for roading.		Radar calibration is in progress.
	An error (ERR) is present on the “Layer Assignment” screen or an “As Applied” application fault is active. Data logging is not possible until the problem is corrected.		

DISPLAYS

ICON LEGEND (continued)

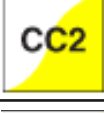
Warning icons

The below tables provide a quick overview of the warning icons which may display in the status and warning icon area while planting.

ICON	MEANING	ICON	MEANING
	A product controller – seed, fertilizer, etc. – is at maximum duty.		A product controller – seed, fertilizer, etc. – is at minimum duty.
	A vacuum controller fault is active.		A seed controller fault is active.
	A bulk fill controller fault is active.		A liquid fertilizer controller fault is active.
	An error (ERR) is present on the “Layer Assignment” screen or an “As Applied” application fault is active. Data logging is not possible until the problem is corrected.		Vacuum fan and/or bulk fill fans are driven by a PTO pump. Engage the PTO before turning the fans ON.
	A rate controller is operating in a degraded state.		A rate controller is disabled.
	A frame controller is operating in a degraded state.		A frame controller is disabled.
	A steering controller is operating in a degraded state.		A steering controller is disabled.
	A CC1 controller is operating in a degraded state.		A CC1 controller is disabled.
	A CC2 controller is operating in a degraded state.		A CC2 controller is disabled.
	A CC3 controller is operating in a degraded state.		A CC3 controller is disabled.

DISPLAYS “RUN LAYOUT” SCREEN WINDOW SELECTION





Planting windows





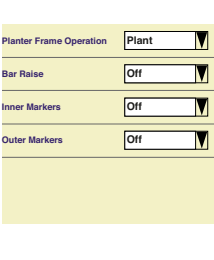

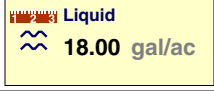
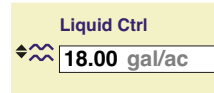
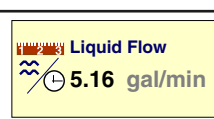
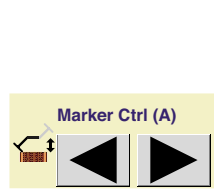
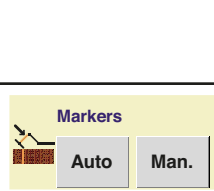
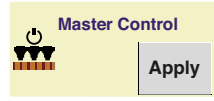
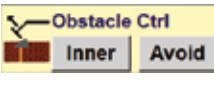
The following table provides a quick overview of the various planting windows to simplify window selection when customizing the left-hand area and “Run” screens on the “Run Layout” screen (Home > Toolbox > Layout).

PLACEMENT LABEL	“RUN”SCREEN WINDOW	DESCRIPTION
Area	Area 0.00 ac	Reports the accumulated acres or hectares planted for the current task.
Area, Total Field	Area, Total Field 0.00 ac	Reports the accumulated acres or hectares planted for the current field, operation, and instance.
Area Farm	Farm Area 0.00 ac	Reports the accumulated acres or hectares planted for the farm since the counter was last reset.
Area Field	Field Area 0.00 ac	Reports the accumulated acres or hectares planted for the field since the counter was last reset.
Area Life	Lifetime Area 0.00 ac	Reports the accumulated acres or hectares planted since the counter was last reset. The counter should remain active as long as the display is in service.
Area Season	Season Area 0.00 ac	Reports the accumulated acres or hectares planted for the season or since the counter was last reset.
Bins, Granular	Granular Bins L R	Reports when the product level is low in the on-row granular chemical hoppers when the planter is equipped with two sensors.
Bins, Seed	Seed Bins L R	Reports when the product level is low in the on-row or bulk seed hoppers when the planter is equipped with two sensors.
	Seed Bins L	Reports when the product level is low in the on-row or bulk seed hoppers when the planter is equipped with one sensor.
Boundary Control	Boundary Control On	Use this control window to temporarily turn boundary control OFF or ON.
Bulk Ctrl	Bulk Fill Ctrl 3000 rpm	Controls the target fan speed used to deliver seed from the bulk hoppers to the minihoppers on the row units.
Bulk Fill Weight (Gross)	Bulk Wt (Gross) 4010 lbs	For planters that are equipped with bulk fill scales, this window reports the gross weight of the bulk fill tanks.
Bulk Fill Weight (Net)	Bulk Wt (Net) Press to Tare	For planters that are equipped with bulk fill scales, this window reports the net weight of the bulk fill tanks – the gross weight minus the tare weight.
Bulk Rate	Bulk Fill Rate 3000 rpm	This window reports the current speed of the bulk fill fan in RPM.
Clutch Ctrl, Manual, 2x4	Manual Row Clutch Control Run 5 All On All Auto All Off 1 (A) 2 (A) 3 (A) 4 (A) 5 (A) 6 (A) 7 (A) 8 (A) 9 (A) 10 (A) 11 (A) 12 (A) 13 (A) 14 (A) 15 (A) 16 (A) 17 (A) 18 (A) 19 (A) 20 (A) 21 (A) 22 (A) 23 (A) 24 (A)	Use this 2x4 window to manually control the ON/OFF state of the configured row clutch groups. <ul style="list-style-type: none"> Each numbered button represents a row unit. Touch any button within an assigned group to activate all buttons in that group. The icons below the numbered buttons
Clutch Ctrl, Manual, 2x6	Manual Row Clutch Control Run 5 All On All Auto All Off 1 (A) 2 (A) 3 (A) 4 (A) 5 (A) 6 (A) 7 (A) 8 (A) 9 (A) 10 (A) 11 (A) 12 (A) 13 (A) 14 (A) 15 (A) 16 (A) 17 (A) 18 (A) 19 (A) 20 (A) 21 (A) 22 (A) 23 (A) 24 (A)	Use this 2x6 window to manually control the ON/OFF state of the configured row clutch groups. <ul style="list-style-type: none"> Each numbered button represents a row unit. Touch any button within an assigned group to activate all buttons in that group. The icons below the numbered buttons
Comp. Pressure	Comp. Pressure 150 psi	This window reports the total compressor pressure available to the software-controlled down pressure system in kPa or psi.
Down Force	Down Force 100 lbs	This window reports the total down force achieved by the system from pneumatic pressure.
Down Force Ctrl	Down Force Ctrl 100 lbs	This window controls the set point for the software-based pneumatic down pressure system.
Down Pressure	Down Pressure 39 psi	This window reports the pneumatic pressure needed to achieve the set point in kPa or psi.

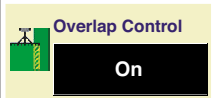
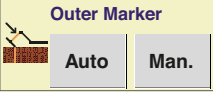
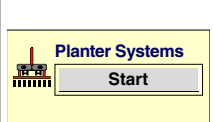
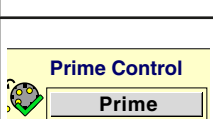
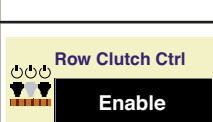
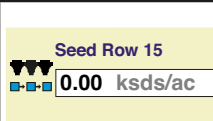
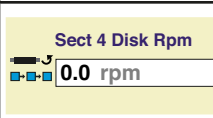
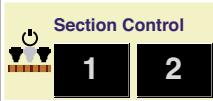
DISPLAYS

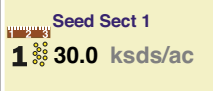
Planting windows (continued)

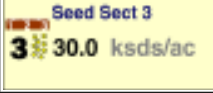
PLACEMENT LABEL	"RUN"SCREEN WINDOW	DESCRIPTION
Frame Control		This window controls planter frame operation (plant, fold, unfold and off), toolbar operation, and marker operation. The window duplicates the functionality of the "Frame Control" screen (Home > Remote Valves > Frame), but can be placed on the "Run" screens.
Implement Steer Angle		This window reports the implement steering angle.
Inner Marker		This window controls inner marker operation on pivot-transport planters.
Liquid		This window reports the actual applied rate for liquid product.
Liquid Ctrl		Controls the liquid fertilizer application rate for any ground drive planter and any variable drive planter using "All Section" seed control.
Liquid Flow		Reports the flow of liquid product through the flow meter in terms of volume over time.
Marker Ctrl		In "Manual" mode, use this window to select the next marker to deploy when the planter toolbar is lowered. In "Automatic" mode, use this window to select the first marker to deploy for automatic marker alternating. This window also reports the current mode of operation: (M) for "Manual" and (A) for "Automatic."
Markers		Controls operation mode – "Automatic" or "Manual" – for the markers on all other planters
Master		Controls all product application for the entire planter – seed, liquid fertilizer, and granular chemical.
Obstacle Ctrl		Controls marker operation when avoiding a field obstacle on pivot-transport planters.
		Controls marker operation when avoiding a field obstacle on all other planters.

PLACEMENT LABEL	"RUN"SCREEN WINDOW	DESCRIPTION
Overlap Control		Use this control window to temporarily turn overlap control OFF or ON.
Outer Marker		Controls the operation mode – "Automatic" or "Manual" – for the markers on pivot-transport planters
Planter Systems		Once hydraulics are enabled, the "Start" button automatically turns on vacuum, bulk fill fan, product master, and, on variable rate (hydraulic seed drive) planters, primes the planter.
Prime Ctrl		Control window to prime the seed meters, the granular chemical drives, and liquid fertilizer applicators, as equipped.
Row Clutch Ctrl		Use this control window to turn the pneumatic or electric row clutch system ON or OFF for all row units.
Row Scan		Reports the applied rate from each seed sensor, one row at a time, followed by the average applied rate (depending on the selected planter control).
RPM Scan		Reports the average seed disk rpm for each section on the planter.
Section 1 2		Controls all product application for section 1 and section 2 of the planter
Section 3 4		Controls all product application for section 3 and section 4 of the planter
Seed 1		Continuously reports the average seed applied rate for section 1
Seed 2		Continuously reports the average seed applied rate for section 2
Seed 3		Continuously reports the average seed applied rate for section 3
Seed 4		Continuously reports the average seed applied rate for section 4

DISPLAYS

Planting windows (continued)

PLACEMENT LABEL	“RUN”SCREEN WINDOW	DESCRIPTION	PLACEMENT LABEL	“RUN”SCREEN WINDOW	DESCRIPTION
Seed Avg		Continuously reports the average seed applied rate for the entire planter	Seed Graph 1 x 1		Displays a bar graph of current planting performance for each row unit relative to the target population rate in a one column by one row format
Seed Ctrl		Controls the seed application rate for any ground drive planter, and any variable drive planter using “All Section” seed control	Seed Graph 1 x 2		Displays a bar graph of current planting performance for each row unit relative to the target population rate in a one column by two row format
Seed Ctrl 1		Controls the seed application rate for section 1 of any variable drive planter with two or more sections that is using “Per Section” seed control	Seed Graph 2 x 2		Displays a bar graph of current planting performance for each row unit relative to the target population rate in a two column by two row format
Seed Ctrl 2		Controls the seed application rate for section 2 of any variable drive planter with two or more sections that is using “Per Section” seed control	Seed Scan		Continuously reports the average seed applied rate section by section on the planter, cycling through all sections.
Seed Ctrl 3		Controls the seed application rate for section 3 of any variable drive planter with two or more sections that is using “Per Section” seed control	Signal Watch, Planter		Reports user selected signals for the planter frame and ECU's as set up on the “Planter Signal Monitoring” screen (Home > Diagnostics > Signals).
Seed Ctrl 4		Controls the seed application rate for section 4 of any variable drive planter with two or more sections that is using “Per Section” seed control	Spacing Scan		Reports the spacing between seeds for each row unit, cycling through all rows one row at a time, and then reports averages
Seed Ctrl L		Controls the seed application rate for the left side of any variable drive planter with two sections that is using “Per Section” seed control.	Vacuum 1		Reports the current vacuum rate for vacuum fan 1 in inches of H ₂ O
		Controls the seed application rate for the left side of any variable drive planter with four sections that is using “Per Section” seed control.	Vacuum 2		Reports the current vacuum rate for vacuum fan 2 in inches of H ₂ O
Seed Ctrl R		Controls the seed application rate for the right side of any variable drive planter with two sections that is using “Per Section” seed control.	Vacuum Ctrl		Controls the target vacuum rate used for all vacuum fans on the planter to hold seed on the seed disks while planting
		Controls the seed application rate for the right side of any variable drive planter with four sections that is using “Per Section” seed control.	Vacuum Rate		Reports the current vacuum rate for one fan in inches of H ₂ O
			Vacuum Rate		Reports the current vacuum rate for all fans in inches of H ₂ O
			Vacuum Scan		Reports the current average vacuum rate for vacuum fan 1, vacuum fan 2 and then the entire planter in inches of H ₂ O

1200 SERIES EARLY RISER® PLANTER

DISPLAYS

Advanced Seed Sensing Windows

The following table provides a quick overview of the advanced seed sensing windows that are available when AccuStat advanced seed sensing has been activated.

NOTE: The following windows are not available until AccuStat has been activated. Contact your dealer for an activation code. See the AFS Pro 700 software operating guide for information about the “Feature Activation” screen.

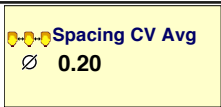
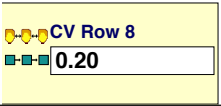
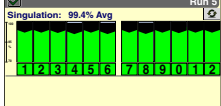
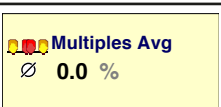
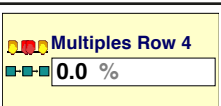
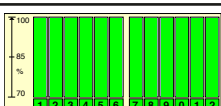
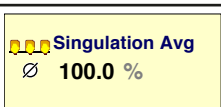
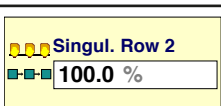
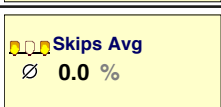
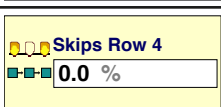
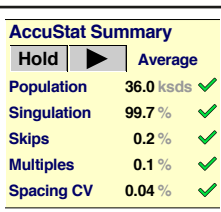
PLACEMENT LABEL	“RUN”SCREEN WINDOW	DESCRIPTION
AcStat CV Avg		Reports the seed spacing coefficient of variation for the entire planter.
AcStat CV Scan		Reports the seed spacing coefficient of variation for each seed sensor, one row at a time, followed by the percentage for each section and the average for the entire planter.
AcStat Graph 2x2		Reports the advanced seed sensing averages for the entire planter and displays a graph of individual row unit performance. For the applicable crop types, the graphs' colors are determined by the AccuStat threshold settings.
AcStat Multiples Avg		Reports the average multiples percentage for the entire planter.
AcStat Multiples Scan		Reports the percentage of multiples for each seed sensor, one row at a time, followed by the percentage for each section and the average for the entire planter.
AcStat Singul. Grph 1x1		Displays the singulation percentage for each row in bar graph form. For the applicable crop types, the graphs' colors are determined by the AccuStat threshold settings.
AcStat Singulation Avg		Reports the average singulation percentage for all planter rows.
AcStat Singulation Scan		Reports the current singulation percentage for each seed sensor, one row at a time, followed by the average percentage for each planter section, the percentage for the rows currently reporting the high and low values, and the average percentage for the entire planter.
AcStat Skips Avg		Reports the average skip percentage for the entire planter.
AcStat Skips Scan		Reports the percentage of skips for each seed sensor, one row at a time, followed by the percentage for each section and the average for the entire planter.
AcStat Summary 1x3		<p>This window reports a summary of all advanced seed sensing information in a single 1 x 3 window. The window cycles to report:</p> <ul style="list-style-type: none"> • The average population and seed sensing information for the row unit with the lowest value for each category • The average population and seed sensing information for the row unit with the highest value for each category • The average population and seed sensing information for the entire planter

STORAGE

PREPARING FOR STORAGE

Proper planter storage practices are a key element in maintaining your planter's accuracy and efficiency. Refer to the planter Operator's Manual for specific steps to secure your machine for storage.

1. Fold markers and set storage locks as specified in the Operator's Manual. Park the planter on appropriate storage stands.
2. Make sure tires are properly inflated.
3. Disconnect hydraulic and electrical lines. Cover connectors to prevent dirt contamination during storage.
4. Remove and clean seed meters. Inspect parts for wear. Reassemble meter covers to meter housings.
5. Store seed disks on a flat surface to prevent damage. Disks may also be stored by hanging them through the center hole. Identify seed disks to assure they are returned to the same meter housings when placed back into service.
6. Completely empty and clean bulk hoppers and seed boxes.
7. Coat exposed hydraulic cylinder rods with grease to prevent rust.
8. Clean ground-engaging parts, and coat with grease or Case IH TILCOAT to prevent rust during storage. (Purchase TILCOAT from your Case IH dealer in aerosol, part number 1132221N, or in larger bulk containers)
9. Remove drive chains and store in a container of clean oil or diesel fuel.
10. Following proper procedures for handling farm chemicals, clean granular chemical hoppers. Re-install hoppers to their original row units.
11. Clean and lubricate the planter. Use touch-up paint as necessary.
12. Check ground engaging components for wear, and replace as needed
13. Inspect electrical harnesses and hydraulic hoses. Make necessary repairs to worn or damaged areas.
14. Clean and inspect the vacuum system.
15. Check and re-tighten hardware.
16. Release pressure from the AccuRow or Pneumatic Down Pressure air systems if applicable. Open drains and allow accumulated water to escape. Make sure the air compressor is protected from the elements during the storage period.
17. Remove the covers from the AccuRow clutches and blow any accumulated dust out of the clutch with compressed air. Excessive dust buildup in the clutch will cause it to slip under load.
18. Lubricate AccuRow clutches. Remove the air line and apply one drop of SAE 10W oil or air tool oil into each cylinder and cycle clutch several times before storing.





SAFETY NEVER HURTS!™ Always read the Operator's Manual before operating any equipment. Inspect equipment before using it, and be sure it is operating properly. Follow the product safety signs, and use any safety features provided. CNH America LLC reserves the right to make improvements in design and changes in specifications at any time without notice and without incurring any obligation to install them on units previously sold. Specifications, descriptions and illustrative material herein are as accurate as known at time of publication, but are subject to change without notice. Availability of some models and equipment builds varies according to the country in which the equipment is used.